



Electronic

TUBES

G-E HAM NEWS

Copyright 1955, by General Electric Company

TUBE DEPARTMENT

GENERAL ELECTRIC

Schenectady 5, N. Y.

MARCH-APRIL, 1955

VOL. 10-NO. 2

HIGH ATTENUATION LOW-PASS AUDIO FILTER

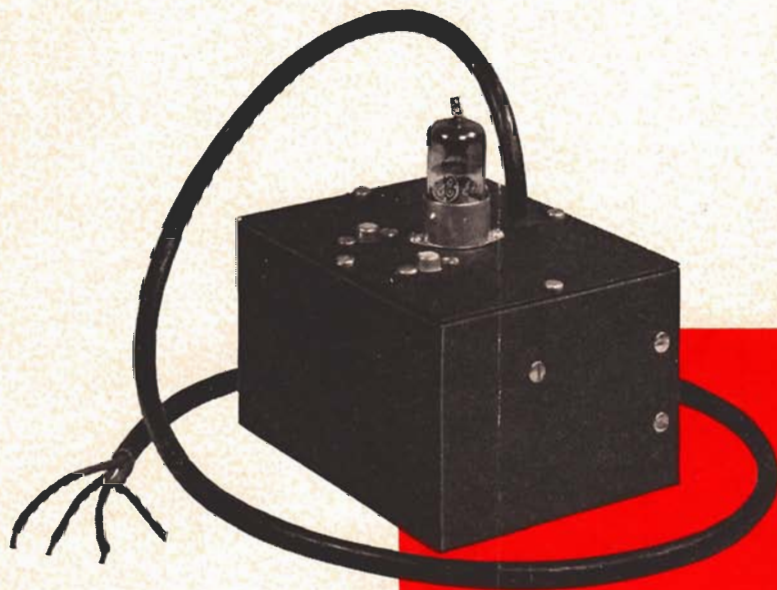

**INTRODUCING
A NEW COLUMNIST
FOR "OPERATION CRYSTAL"**

This audio filter for receiver or speech amplifier uses inexpensive unshielded coils plus a few of W2KUJ's slick tricks to obtain an attenuation slope approaching that possible with high-priced toroid coils.

—Lighthouse Larry

CONTENTS

"Operation Crystal".....	page 2
Low-pass Audio Filter.....	page 3
Thumbnail Theory.....	page 6
Sweeping the Spectrum.....	page 7



OPERATION CRYSTAL

The ideas for OPERATION CRYSTAL (see G-E HAM NEWS, Volume 10, No. 1) have been rolling in so fast that Lighthouse Larry has had to add the character you see in the above heading to his staff. Gentlemen: Meet "DANNY DIODE," now in charge of this department. He has had a tough time choosing the three ideas and circuits published below which qualify for the certificates for \$10 in G-E Electronic Tubes. All ideas submitted before December 1, 1955, will be considered for publication in the next five issues of G-E HAM NEWS. Send your idea in to Danny Diode today!!

—Lighthouse Larry

"KNOB TWISTER'S SPECIAL"

This circuit well deserves the above title for it has five tuning adjustments, two of which are ganged for convenience! William Patzer, W8RWX, Benton Harbor, Michigan, says that the 1000-watt local broadcast station was received with enough volume to drive a 4-inch speaker in a quiet room. The selectivity is adequate to separate all the Chicago stations, about 70 miles away, with good earphone volume.

The diagram shows the vari-loopstick coils L_2 and L_3 , coupled to L_1 and L_4 . These are 30 turns of No. 26 DSC wire wound on a close-fitting cardboard sleeve placed over the winding on the loopstick. The sleeve may be held in place with scotch tape or model-airplane cement after positioning for maximum gain. C_1 and C_3 is a dual 365-mmfd variable condenser salvaged from an old broadcast receiver. C_2 is a 0.005-mfd ceramic condenser, and the diode is a 1N48 or 1N52. Some adjustment in the L/C ratio in the tuned circuits can be obtained by adjusting the tuning slugs in the

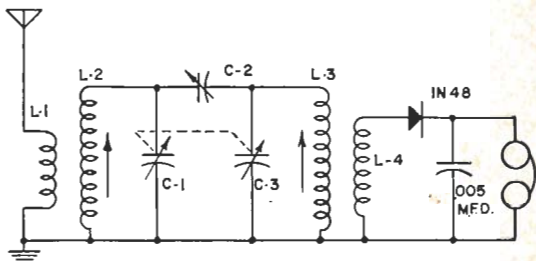

loopsticks for maximum volume as well as for proper tracking of the tuned circuits when several stations are to be received. The coupling condenser, C_2 , is a 3-30-mmfd compression type trimmer. It is adjusted for maximum volume on local stations or maximum selectivity on distant stations. Imagine a crystal receiver with a selectivity control!!

"FURSCHLUGGINER" MODEL

This tricky little circuit was submitted by Curt Olofsson, W6GTY, who claims it was designed by a Dr. Smerdschlossenzwiehammerschtenkel. A measure of impedance matching is provided by the 350-mmfd ceramic trimmer condenser in series with the 1N48 crystal diode. Curt says this really brings up the signal strength when the set is used with a short antenna (25 to 30 feet). The salvaged broadcast receiver antenna coil shown in the diagram is connected "backwards," with the primary winding in the crystal detector circuit. Modern slug-tuned coils are also suitable, such as the Meissner 14-1026 or 14-1056; or a Miller 6300 or 70-A. W6GTY also recommends that medium impedance earphones (about 2000 ohms) be used in preference to high-impedance types (20,000 ohms). He built this

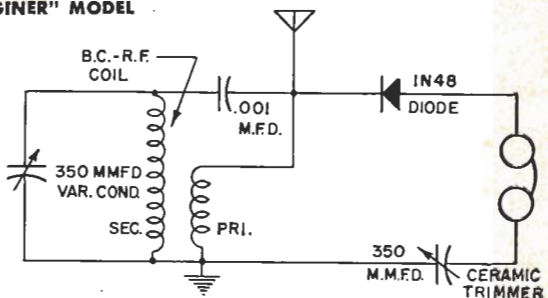

particular model into an old cigar box, but hasn't pulled in Havana yet!!!

"DRINKING GLASS RECEIVER"

A clever arrangement built around a 2-inch-diameter plastic drinking glass was master-minded by Jack Lanabuth, an eighth-grade school student who unfortunately did not include his street address with his entry. (Please send it to Lighthouse Larry when you read this so I can send you the award certificate for your \$10.00 in G-E Electronic Tubes.) He states that WBAA, Purdue, and WASK, Lafayette, Indiana, are received very well using a 25-foot antenna and his bedspring for a ground! This set is another cigar-box construction job.

The 60-turn close-wound coil of No. 26 DSC wire on the 2-inch form figures out to approximately 140 uh and tunes with a standard single-gang 420-mmfd variable condenser. The 10-turn antenna and 20-turn detector coils are wound over the 60-turn coil with a

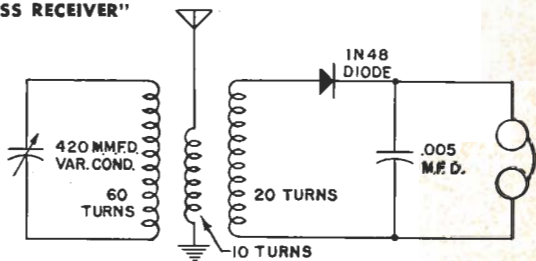

layer of plastic electrician's or scotch tape for insulation. The selectivity of this circuit is also fairly good because the 1N48 crystal diode does not load the tuned circuit heavily.

LOW-PASS AUDIO FILTER

A sharp cut-off low-pass filter is a great help in eliminating the annoyance of heterodynes and noise beyond the range necessary for completely satisfactory phone reception. The filter described here is an inexpensive and highly effective weapon in the fight against QRM. Used in the speech system of a transmitter, this filter reduces the spectrum space occupied by the signal, while actually increasing the effectiveness of the transmission. It is connected as shown in Fig. 1.

Because the filter is intended for a variety of applications, a vacuum tube is employed to provide high input and low output impedance. Thus, all the requirements of impedance matching for the passive elements of the filter are satisfied internally and are not disturbed when the filter is interposed between a wide variety of devices.

The design cut-off frequency of the filter pictured on the cover of this issue of G-E HAM NEWS is 3000 CPS, a figure generally considered adequate for voice communication. Design data is given for the prototype low-pass filter in "Thumbnail Theory" for those who want to design their filter for a different cut-off frequency. It is suggested that the 3000 CPS cut-off design be used unless it is certain that a different cut-off point is required for some specific application.

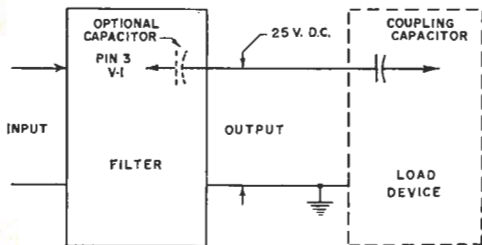

Fig. 1 Diagram for connecting the low-pass filter to the input and load devices.

CONSTRUCTION

The entire filter is housed in a 3 x 4 x 5-inch utility box drilled as shown in Fig. 2. The tube socket, input and output jacks are mounted on one cover. Although

the filter elements are not in "cramped" space, a certain amount of clearance is required between coils in different filter sections. The circuit diagram and parts list are shown on page 5.

The six 125-mh coils are mounted on the aluminum brackets shown in Fig. 3 with 6-32 brass machine

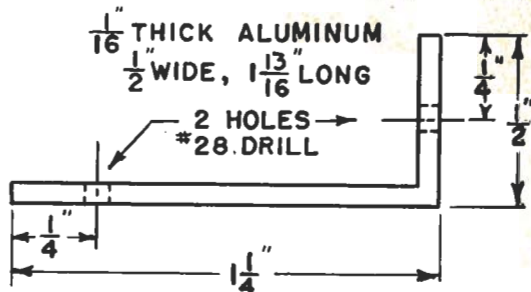

Fig. 3 Mounting brackets for the coils.

screws 1 inch long which pass through the centers of the coils. The brackets are then fastened to the 3 x 4-inch ends of the box, as pictured in Fig. 4. Note how L_1 and L_6 are mounted with respect to the other coils. All the wiring between the coils, condensers C_1 , C_2 , C_3 and the 2400-ohm terminating resistor is done with the covers removed. Attach 4-inch leads to the input end of L_1 and the output end of L_6 for later connection to the tube socket.

The brackets holding L_1 and L_6 should not be securely tightened until after performance tests are completed. Do not rely on the steel box to provide the ground path indicated in the circuit diagram. Instead, run a lead to the grounded ends of C_1 , C_2 and R_1 , and bring this lead out to the ground points on the top cover. Heater and plate power are supplied through a four-conductor cable anchored to the cover.

TESTS

After a wiring check, heater and plate voltage can be applied. Approximately 25 volts DC should appear across the output resistor. If the correct values of inductors and capacitors have been used, the performance

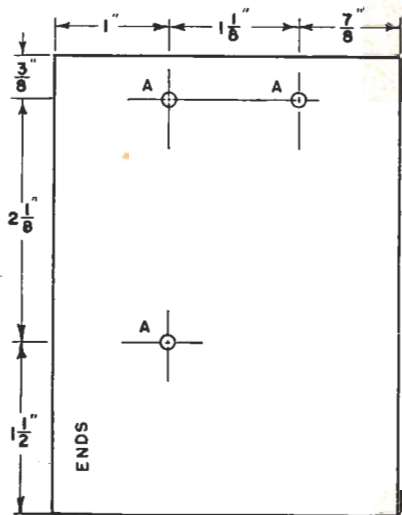
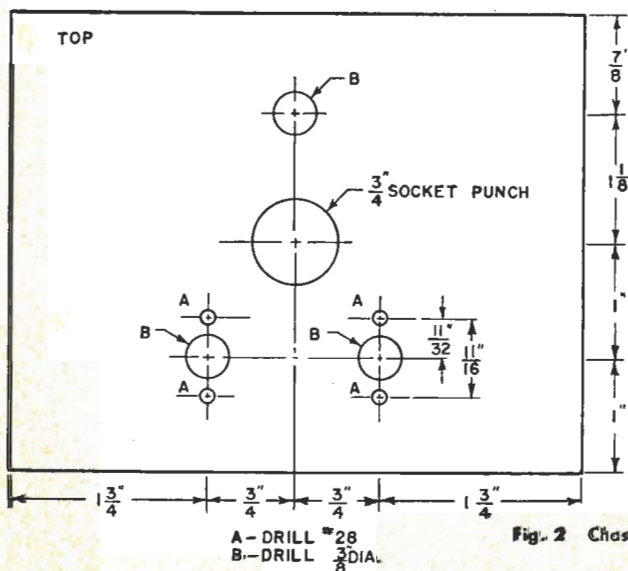

Fig. 2 Chassis drilling layout.

A - DRILL #28
B - DRILL 3/8" DIA.

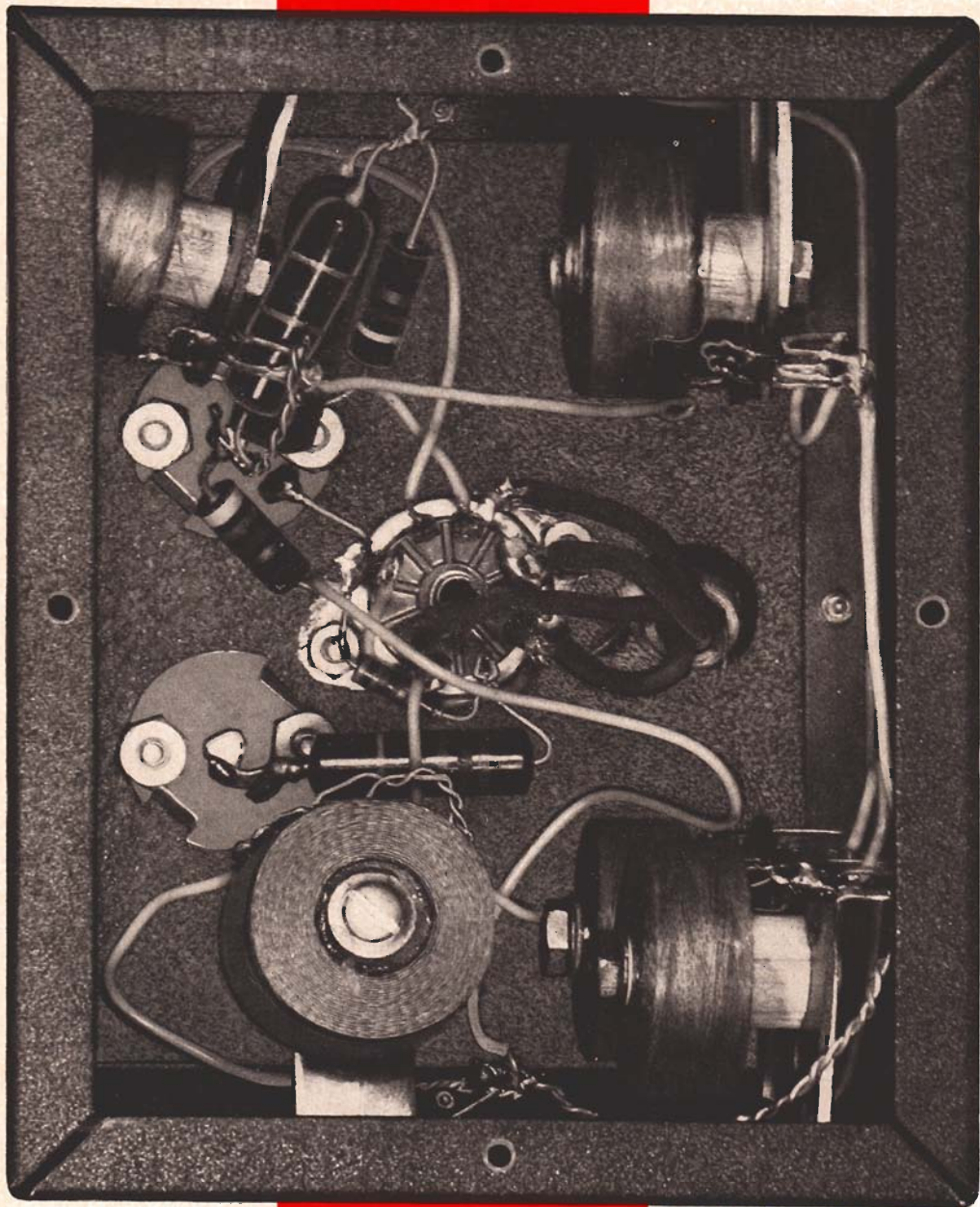
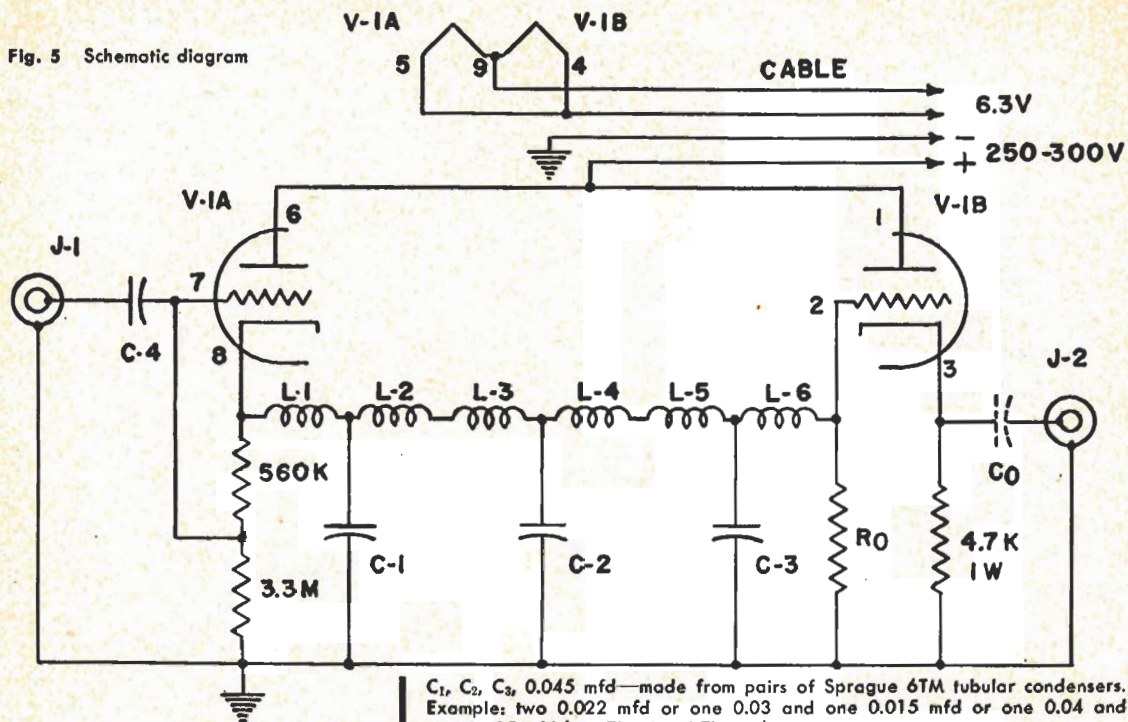

Fig. 4 Bottom view of filter showing socket placed with pins 1 and 9 toward phono jacks. Solder lugs under coil bracket mounting screws are used as ground tie-points for C_1 , C_2 and C_3 .

Fig. 5 Schematic diagram



PARTS LIST

C₁, C₂, C₃, 0.045 mfd—made from pairs of Sprague 6TM tubular condensers. Example: two 0.022 mfd or one 0.03 and one 0.015 mfd or one 0.04 and one 0.005 mfd (see Thumbnail Theory).
 C₄—0.01 mfd, 600 volts.
 C₀—Capacity dependent on load impedance, see text (Application).
 J₁, J₂—Cinch shielded phono jacks.
 L₁—L₆—125 mh RF chokes (Meissner 19-6848).
 R₀—2400 ohms, 1 watt ±5%.
 V₁—12AT7 tube.
 All resistance values in ohms, ½ watt ±20% except as noted. K=1000.

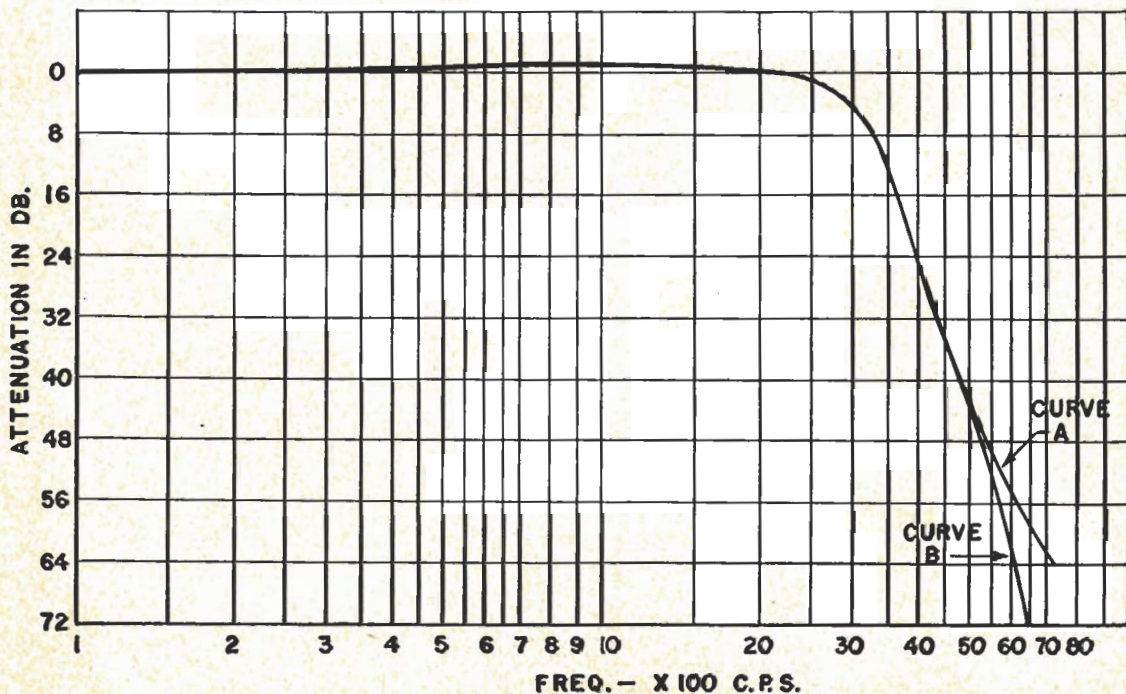

Fig. 6 Response curves with and without coils oriented.

will be that shown by the curve "A" of Fig. 6, at least to an attenuation of 30 db without any further work on your part. Usually an improvement in attenuation at frequencies higher than 4000 CPS can be made by orientation of L_1 and L_6 , if suitable measuring equipment is available. Tests made by ear alone are not sufficiently reliable to warrant the effort. A reliably calibrated audio oscillator covering a range from 100 to 10,000 CPS at an output voltage of about 10 volts RMS, and an output indicator covering a range of at least 60 db (1000 to 1 in voltage) are required.

In case orientation of L_1 and L_6 through a few degrees does not allow an attenuation of 60 db or more to be obtained at 6000 CPS, reversal of connections to either L_1 or L_6 (but not both) should allow the performance shown in curve "B" to be equalled or surpassed in the region of high attenuation. The final adjustment of the filter model shown in the illustrations was obtained by setting the test frequency at 7000 CPS and bending the brackets holding L_1 and L_6 for minimum output. Tests with an oscilloscope revealed that the minimum was really a null at 7000 CPS and that the measured output 85 db below the reference level was hum and noise. Beyond 7000 CPS the output rose to about 70 db below reference level and dropped slowly above 10,000 CPS. The insertion loss of this filter is 7 db; that is, the output voltage at 100 CPS is 7 db less than the input voltage. This loss is a consequence mainly of the resistance of the choke coils used.

APPLICATION

The maximum operating level for the filter is 10 volts RMS at the input. Operation at higher levels will introduce distortion due to overloading of the input triode. Practical operating levels will range between 1 and 10 volts. Operation at lower levels will, of course, degrade the signal-to-hum ratio. It will be observed that the hum level in the output is determined by the amount of stray magnetic field in the vicinity of the filter since the coils are not magnetically shielded. A power supply is not included as part of the filter for this reason. Ordinarily, the small amount of heater and plate power required can be borrowed from other apparatus with which the unit is used. If excessive hum is experienced, try moving the filter to a more favorable position, or orienting it for minimum hum pickup.

As a receiving accessory, the filter is inserted in an audio circuit where the operating levels are within range. In most receivers, the output of the first audio stage will provide a suitable signal level for the filter input. When used with the Signal Slicer (G-E HAM NEWS, Volume 6, No. 4) the filter should be inserted between the slicer output and its succeeding audio amplifier. Note that the 4700-ohm output resistor should not be short-circuited by the device into which the filter operates. A coupling capacitor with reactance equal to one-tenth the input impedance of the load at the lowest desired frequency should be provided at the input to any such load (see Fig. 1). Such a capacitor can be incorporated as part of the filter unit to avoid mistakes.

Whether the crystal filter in the receiver is used or not, this filter will improve CW reception somewhat even though the bandwidth is greater than needed for that application. The improvement obtained will depend on the characteristics of the receiver and the particular QRM problem encountered.

For use as a bandwidth control in transmission, the filter is inserted in the audio circuits at a point where the operating levels are suitable. The above precautions regarding the load circuit should be observed. When used in conjunction with the SSB Jr. exciter (G-E HAM NEWS, Volume 5, No. 6) the filter output can connect directly to the audio input jack of the exciter

if an 0.01 mfd coupling condenser is inserted in either the filter output or exciter input.

The filter characteristics do not provide for attenuation of low frequencies. Where it is desired to tailor the audio response of the transmitter, this may be done in the circuits either preceding or following the filter. When low-frequency attenuation is introduced after the filter, hum pickup in the filter itself will be attenuated. (See G-E HAM NEWS, Volume 4, No. 4, for simple means of introducing low-frequency attenuation in speech amplifier circuits.)

The "dyed-in-the-wool" experimenter will find many other applications for a handy sharp cut-off filter such as the one described here. Even though the filter is normally used in only one place (say as part of the receiver setup) it will be found convenient to provide input and output jacks so that the device may be patched into other apparatus as the need occurs. In this way a single filter can be made to serve a variety of uses.

THUMBNAIL THEORY

The design of filters can not be covered very thoroughly in a few paragraphs. For those who want some background information on filters the following will be of interest.

The basic filter section used in the device described in this issue is called the "constant K prototype," shown in Fig. 7. Any number of these sections may be joined together for greater attenuation beyond the cut-off frequency. When this is done, the internal sections can be considered as either π or T sections. A multiple section filter is called a "composite" filter. In the ideal case, a constant K filter must be driven by a source having an internal impedance equal to the characteristic impedance of the filter section and

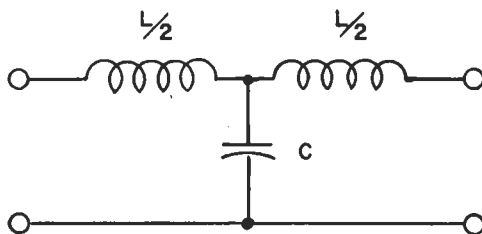
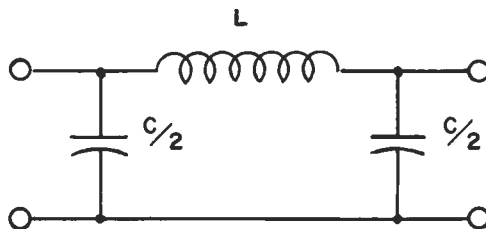

Fig. 7 Above is a T structure filter section. When several T's or π 's are joined in a complete filter, the internal sections lose their identity.

Fig. 8 Below is a π structure filter section.



the filter must be terminated by the same impedance. Ideally, too, the filter elements should be perfect reactances. Practically speaking, the characteristic impedance varies throughout the pass-band of the filter. Of course, the filter elements do have loss (they are not perfect reactances) so that other considerations

(continued on page 8)

SWEEPING *the* SPECTRUM



Doggone it!—I just get one editor really broken in so that everything here at the G-E HAM NEWS office is running smoothly when he turns around and lands a new job. W2ZBY will be in charge of the Tube Department News Bureau which is now being organized. This new man, W2JZK, looks like a real tough boy to work for. No more "coffee breaks" for me for a while until I get him whittled down to size. Anyway, best wishes for success to W2ZBY in his new venture.

* * *

Our editor is constantly checking with the "unofficial" technical staff here at General Electric to see what interesting gear or subjects they have in mind. These projects are intended to have wide popular appeal. Therefore, each one must be fairly easy to construct using standard manufactured parts unless the performance requirements dictate some special component. We receive letters every day asking when we are going to publish a specific design. Ideas for future issues are largely initiated by such communications, so if you haven't seen what you would like to build in G-E HAM NEWS, write and present your thoughts on the subject.

* * *

THE RADAR MAN

*If you should see upon the street
A man who walks with dipole feet,
With a train of little pips behind
He's a radar man with a micro-mind.*

*With micro-seconds and micro-waves
And micro-volts he fills his days.
And thus in the course of time we find
His brain has shrunk to a micro-mind.*

*His eyes give out a neon gleam
His ears fan out like a radio beam
As he chews, his molars oscillate
And his heart pumps blood at a video rate.*

*This man obtains with passing years
Infinite impedance between his ears
And at last he succumbs to a heavy jolt
When he gets what he thinks is a micro-volt.*

*The doc looks up from his microscope
And says to his nurse, behold this dope.
No trace of a brain cell, can I find
He's a Radar Man with a micro-mind!*

—WφPPX in "Ham Hum"
Ak-Sar-Ben—R. C., WφEQU

The G-E HAM NEWS photographer is now out in San Diego County, Calif., getting some pictures of 1954 Edison Radio Amateur Award winner Ben Hamilton, W6VFT, in action at his outstanding civil defense and disaster service installations. Look for them in the next issue of G-E HAM NEWS.

* * *

The Edison Radio Amateur Award judges also named two other nominees, Carl J. Theis, W8BKH, and Carter Rogers, W8NCS, for Special Citation award certificates.

Theis, of Cleveland, Ohio, has received much acclaim for his work of designing, converting and constructing two-way radio equipment from war-surplus command sets for use by missionaries overseas. More rapid communication between isolated missions made possible by these sets was instrumental in summoning life-saving medical aid on several occasions.

When his home town of Richwood, West Virginia, was cut off from the rest of the area by a flash flood and power failure, Rogers was able to enlist the aid of the necessary disaster services through use of a friend's mobile amateur radio station. A more serious threat to the flood-ravaged town was averted through his prompt action.

* * *

One of the complaints our new boss often airs is that his typewriter is old and rickety. (Please note: the typewriter—and only the typewriter—is old and rickety.) It does strange things, this machine. And the latest was to coin a word, "modulation," which could come into common use on the ham bands. It could be used to describe the system by which all too often we produce a Q 1—R 1 signal!

* * *

About back copies of G-E HAM NEWS . . . We still have available back copies of some issues in sufficient supply to send bulk quantities to clubs or Hamfests, Drop us a note and we'll be glad to send whatever quantity you need as long as the supply lasts.

* * *

The mail basket informs us that somewhere in the land there is an occasional victim of the editorial abbreviation style used in G-E HAM NEWS. Hereafter, the said style will be altered to include the spelling out of abbreviations such as SSB, SSSC, DSRC, etc., the first time they are used in a particular issue. (Sincere apologies to anonymous.)

—Lighthouse Larry

THUMBNAIL THEORY (continued from page 6)

enter into the design of filters. Even when perfect filter elements are assumed, the variation of characteristic impedance within the pass-band presents a problem that is solved partially by more complex circuit arrangements known as "M-derived" filters.

In filter design, as in most things, a compromise must be made between performance and complexity, or cost. In our case, certain liberties were taken with classical filter theory to provide acceptably good performance with basically straightforward and simple circuits. A low source impedance is provided by the cathode follower input arrangement shown in the schematic diagram, while the terminating impedance is a resistor of a constant value. These departures cause minor variations of the attenuation within the pass-band. Fortunately, these variations are partially smoothed out by the loss in the filter coils and the approach to ideal operation is thereby improved. Non-ideal filter elements can be used with considerable saving in cost and a less complex filter arrangement can be built. The loss in the coils accounts for the bulk of the "insertion loss" mentioned earlier. About 2 db of the insertion loss is accounted for by the two tube sections used.

The composite filter in this article comprises three identical T sections joined together. Since a low driving impedance is used, no advantage could be achieved by a π structure. Rather than select a certain characteristic impedance and then prune commercial coils to necessary values in order to provide the desired cut-off frequency, the design equation for inductance per section was solved for R_0 , the low-frequency characteristic impedance. Thus:

(1) $R_0 = \pi f c l$, where $f c$ is the cut-off frequency and l is twice the inductance value obtainable. When $f c = 3000$ CPS, then $l = 0.25$ henry.

(2) $R_0 = \pi \times 3000 \times 0.25 = 2360$ ohms. Keeping $f c$ at 3000 CPS, and using $R_0 = 2360$ ohms

$$(3) C = \frac{1}{\pi f c R_0} = \frac{1}{\pi \times 3000 \times 2360} = 0.000000045 \text{ farads.}$$

Thus $C = 0.045$ microfarads.

Equations (1) and (3) can be used in designing low-pass filter sections for other cut-off frequencies if desired. A filter is said to "cut-off" when its attenuation reaches 3 db.

The coils used in the sample filter had an inductance value of 0.125 henry each. The measured Q at 1000 CPS was 2.20. The total value of 0.25 henry required per section is twice the value of the individual coils obtainable. The filter capacitors were made up of two selected commercial plastic-encased paper capacitors connected in parallel to provide the calculated value of 0.045 ufd. The individual capacitors were checked for value and paired for as nearly matched composite values as possible, as well as adherence to the design value required.

The sharpness of cut-off obtained with this filter is greater than that indicated by classical filter theory when constant resistive source and load impedances of the value R_0 are used. This greater attenuation is paid for by the irregularities shown between 1000 and 2500 CPS, a really small price indeed. The additional attenuation obtained beyond the 40 db point by coupling between L_1 and L_6 to provide "infinite" attenuation at 7000 CPS serves to increase the slope of the characteristic between 4000 and 7000 CPS at the expense of smaller attenuation beyond about 10,000 CPS. Although this actual difference is measurable, its practical significance for most applications is very small.

—W2KUJ



Electronic
TUBES

G-E HAM NEWS

Available FREE from

G-E Electronic Tube Distributors

published bi-monthly by

TUBE DEPARTMENT

GENERAL  ELECTRIC

Schenectady 5, N. Y.

In Canada
Canadian General Electric Co., Ltd.
Toronto, Ontario

E. A. NEAL, W2JZK—EDITOR

MARCH-APRIL, 1955

Printed in U.S.A.

VOL. 10—NO. 2

Des Roberts

ELECTRICAL SUPPLY CO.

24-60 MT. VERNON ST., LYNN, MASS.