

HAM TIPS

from

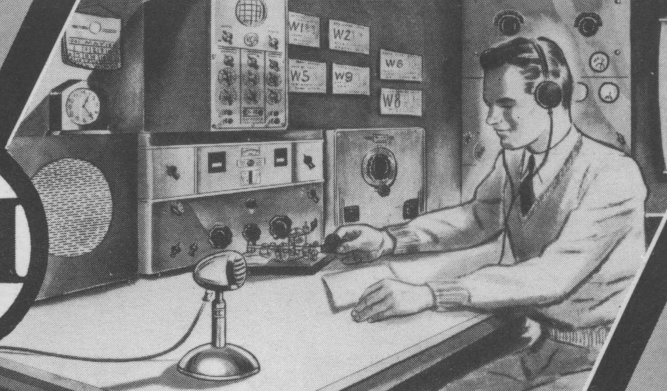

Published by RCA Manufacturing Company, Inc., Camden, N. J., U. S. A.
 CAMDEN, N. J.

VOL. 4 — No. 4

NOVEMBER, 1941

MIDGET TUBES ENJOY WIDE APPROVAL BY HAMS AND ENGINEERS

Small, Low-Cost Types Offer Wide Possibilities in UHF Work

Interest in the RCA-9001, 9002, and 9003 is running high among the uhf gang these days. They are the answer to the need for economical tubes designed particularly for applications requiring high-efficiency, high-gain circuits at unusually high frequencies. Moreover, they have mechanical advantages not to be overlooked since their conventional method of mounting means that they can be inserted and removed from their sockets with ease. And with their maximum height of only 1 1/8" and maximum diameter of only 3/4" they can be made to fit into just about any space.

The 9001 is the sharp cut-off pentode, the 9002 is a triode, and the 9003 is a remote cut-off pentode. All three tubes are heater-cathode types having 6.3-volt, 150-ma. heaters. Static electrical characteristics are quite similar to the corresponding Acorn types, 954, 955 and 956. Grid-plate capacitance of the pentodes is less than 0.01 μf , output capacitance less than 3 μf . Input capacitance for the sharp cut-off pentode is

UHF MIDGET

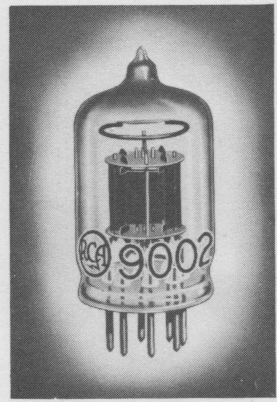

RCA-9001, 9002, and 9003 are the new special Midget tubes for use by engineers, experimenters, and amateurs working in the uhf. They are particularly well suited for FM, Television, and other applications requiring high-efficiency, high-gain circuits at high frequencies.

3.6 μf ; for the remote cut-off pentode, 3.4 μf .

When tubes are designed for use at the uhf, it is desirable that their interelectrode capacitances be low, that the transit-time loading effect be as small as possible, and that the

(Continued on page 3, column 4)

LOW-COST P-P BEAM TUBE FINDS MULTITUDE OF HAM XMTR USES

RCA-815 Delivers 25 to 35 Watts at 112 Mc in Novel Resonant-Line Oscillator

More stations are cropping up on the ultra highs every day. This area of the radio spectrum is attractive. It offers much to the amateur who likes to tinker with new modes of transmission and new types of directive antenna arrays; it provides QRM-free channels for the dyed-in-the-wool rag chews who enjoys chatting with the local boys across town. It's a place for new adventure. It is with these thoughts in mind that we offer an unusual 2 1/2-meter application of the RCA-815 twin beam transmitting tube. This inexpensive little bottle really fills a large gap in the uhf tube line from which the amateur must choose in designing his "ultra-high" gear. Although the 815 really shines as an r-f power amplifier at frequencies up to 225 Mc, we thought a bit of data on its use in a simple, resonant-line oscillator might have interest. Hence, such a gadget was constructed in our Transmitting Tube Laboratories and the complete story follows.

WIN \$5.00!

Checks to the winners of suggestions and station photographs in this issue are on their way to W3EYM, K7FST, and W3NT. Good kinks and good pictures pay off. Send us those little pet ideas and let's see your station photo. Those published win \$5.00 cash.

(This offer is good in Western Hemisphere, Hawaii, and the Philippine Islands.)

Grid Circuit is Tuned

The circuit of the 2 1/2-meter oscillator is shown on this page. Basically, it is of the conventional tuned-plate, tuned-grid type employing "quarter wave" resonant lines in both the grid and the plate circuits. The oscillator is tuned over the 112-116 Mc amateur band by

(Continued on page 2, column 1)

PUSH-PULL RCA-815 OSCILLATOR, 2 1/2 METERS

Power Output 25 to 35 Watts

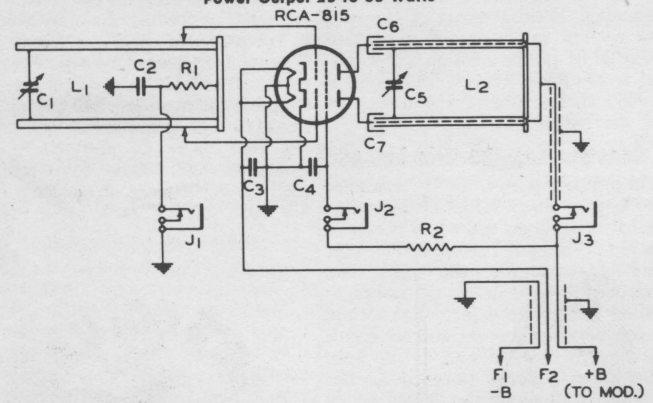

ADDITIONAL PARTS

- 1 RCA-815.
 - 1 Chassis 3/8" aluminum or 16-gauge sheet iron, 4" x 4 1/4" x 1 7/8".
 - 1 Ceramic socket (National #XC-8).
 - 1 Shielded microphone plug (Amphenol #MCF1 and standard microphone plug attachment)
 - 1 Rubber insulating "Boot" (Mueller #29).
- NOTE: The various components which have been mentioned by manufacturers' trade names in this unit are the parts that were actually used. Other parts may be substituted with equally good results, provided they have similar characteristics.
- C₁ C₂—Line Condensers, 2 Discs of 3/16" Copper 2" Diameter mounted on 10-32 Brass Screws.
 - C₃ C₄—0.001 μf mica, 600 v. (Aerovox #1467)
 - C₅ C₇—Plate line d-c isolation condensers 0.010" copper sheet 1" long wrapped around outside of 3/8" tubing, 0.002" mica insulation, spaced 1 1/2" between centers.
 - L₁—Grid Line, 1" O.D. Copper Tubing 21" long, spaced 1 1/2" between centers.
 - L₂—Plate Line, 1 1/2" O.D. Copper Tubing 13" long, spaced 3/8" between centers.
 - R₁—10000 ohm, 1 watt (IRC #BT-1).
 - R₂—15000 ohm, 25 watt (IRC #DHA) (Adjust to 14000 ohms).
 - J₁ J₂ J₃—Meter jacks (Mallory "Midget" #A-2).

Copyright 1941, RCA Manufacturing Co., Inc.

RCA GUIDE HITS NEW HIGHS AMONG POWER TUBE USERS

Amateurs, Engineers find Xmtg Tube Book Invaluable

The RCA Guide for Transmitting Tubes is setting unprecedented records for demand by Hams and Engineers. Its 72 pages are packed with subjects of high interest to all engaged in the art of radio communication. It contains comprehensive data on 69 RCA Air-Cooled Transmitting Tubes. This data is supplemented by carefully proven circuits that show how RCA transmitting tubes may be used to their best advantage.

The RCA GUIDE is bound in a striking red cover and contains more than 150 circuits and illustrations. Get your copy from your RCA Tube and Equipment Distributor or send 25 cents direct to the Commercial Engineering Section, RCA Manufacturing Company, Harrison, N. J.

330 WATTS INPUT

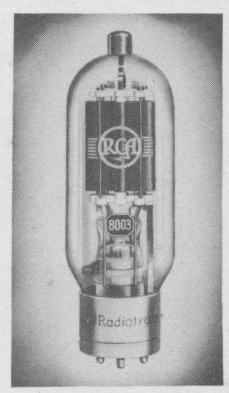

RCA-8003 is "big-time" among the 100-wattners. It will deliver up to one-quarter kw output with the relatively low plate voltage of 1350 volts, it will take maximum ratings up to 50 Mc, it is built particularly to withstand high peak voltages. The 8003 is a thoroughly dependable triode for transmitters or for special applications. It's as rugged as they come.

Low-Cost P-P Beam Tube Finds Multitude of Ham XMTR Uses

(Continued from page 1, column 4)

means of disc-type condensers (C_1 and C_5) mounted near the open end of each resonant line. D-c grid bias for the 815 is provided by the 10,000-ohm grid leak, R_1 . The d-c screen voltage is obtained from the modulated plate supply through dropping resistor R_1 .

In order to remove the d-c plate voltage from the plate lines, the plates of the oscillator are capacitance-coupled to the plate line by means of condensers C_6 and C_7 . The d-c plate voltage is fed to the plate side of these condensers by means of insulated wires (shown in dotted lines) running through the center of each plate rod. The constructional details of condensers C_6 and C_7 are given under CONSTRUCTION. Three meter jacks provide for the measurement of the d-c grid, screen and plate currents. A 0 to 25-ma. and a 0 to 300-ma. meter are suitable for these current measurements.

Circuit is Novel, Clean-Cut

The circuit arrangement, in conjunction with the RCA-815, has a number of worthwhile advantages for uhf operation. These may be summarized as follows:

- (1) Push-pull operation with almost perfect circuit symmetry.
- (2) Minimization of degenerative effects due to low cathode- and screen-lead inductance. The cathodes and screens of the two beam power units are tied together *within the tube* to provide short leads.
- (3) Good frequency stability due to the use of a high-Q grid line.
- (4) Ease of frequency adjustments because both plate and grid lines are tuned with condensers. This arrangement eliminates the use of sliding shorting bars with their usual contact losses and variations in grid drive and plate coupling as the slider is moved.

The Layout is Effective

Before the actual construction of the oscillator is taken up, it may be helpful to explain the reasons for the particular mechanical layout employed. In order to obtain good frequency stability, a high-Q grid line is used, with the grids tapped near the shorted end (current maximum) of the line. It is possible to obtain higher output with the grids connected across the open end of the grid line, because of the greater driving voltage available. However, this connection impairs the frequency stability of the oscillator because it necessitates a physical shortening of the high-Q section of the grid line. One-inch copper tubing was chosen for the grid line because its rigidity eliminates the need for spacing insulators near the voltage end of the line and because it provides the desired high-Q circuit. The 815 has such excellent grid-plate shielding that it

PUSH-PULL 815 OSCILLATOR AT 2½ METERS

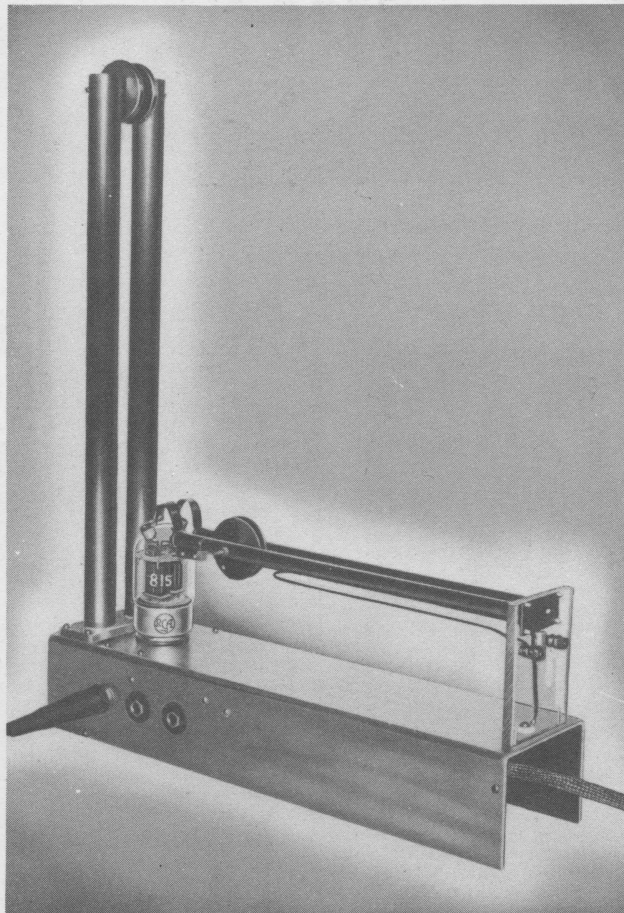

This novel single-tube oscillator delivers 25 to 35 watts on 2½ meters. High-Q lines are used for maximum frequency stability. The oscillator is tuned by capacitive means. This eliminates need for sliding shorting bars and the possibilities of contact losses and grid drive variations.

will not oscillate when the grid and plate circuits are isolated from each other. Therefore, sufficient external feedback must be provided to permit oscillation. The necessary coupling is provided by locating a portion of the grid line near the plate circuit. Since the layout and circuit arrangement have been chosen to minimize parasitic problems and bugs, it is suggested that the layout be carefully followed.

The construction of this oscillator is relatively simple, the type of construction and the general layout used is illustrated on pages 2 and 3. Short leads and adequate grid-plate coupling are obtained by mounting the grid line vertically at one end of the chassis, close to the 815, and by mounting the plate line horizontally above the chassis at a level with the plate terminals. Efficient operation is obtained by supporting each line at points of low r-f potential, and by keeping all insulating materials away from points of high r-f potential. Freedom from frequency wobble is obtained by making use of large copper tubing for the grid and plate lines. These lines are adequately supported on a heavy chassis.

The chassis is made of 1/8" sheet aluminum, bent into a "U" shape 4¼ x 4 x 17½ inches. Sheet alumi-

num was used at the time the model was built but sheet iron may be used with almost equally good results. The 815 grid leads are tapped about 2½ inches from the shorted end of the grid line to minimize the effect of grid-circuit variations on operating frequency. Solid support of the grid line with a minimum of insulating material at points of high r-f potential is provided by two Polystyrene blocks, spaced about 4½ inches at the shorted end of the line.

Constructing the Grid Lines

Grid-line condenser, C_1 , is made of two copper discs 2 inches diameter, mounted on brass screws as noted in the circuit legend. The upper Polystyrene support for the grid line (fastened to the top of the chassis) is drilled with two 1-inch holes, 1½ inches between centers, so that it can be slipped over the end of the line. The lower support (located at the bottom of the chassis) is bolted to the copper shorting plate which in turn is soldered to the lower end of the line. A piece of Bakelite, or similar insulating material, can be substituted for the lower piece of Polystyrene, because this section of the line is very close to ground potential for radio-frequency.

When assembling the grid-line

structure, it is important to mount the tuning-condenser plates first, and then to slip the drilled Polystyrene strip into place before the copper shorting plate is soldered to the lower end of the line. If the assembly is not carried out in this order, it will be impossible to mount the condenser plates. For the soldering operation, the drilled piece of Polystyrene should be slipped to the far end of the line. Polystyrene melts easily. As the soldering iron of the average ham is too small for such large tubing, a blow torch of some kind will usually be necessary.

After the shorting plate has been soldered to the line and allowed to cool, it should be bolted to the lower piece of Polystyrene (or Bakelite, as the case may be). This insulator is then bolted to the bottom edges of the chassis. As can be seen by reference to the top view of the chassis, the grid leads are made of thin copper strips, wrapped and bolted around each grid rod about 2½ inches from the shorted end. A thin copper plate is bolted between the 815 socket and the chassis to provide a common ground for all r-f circuits. Both cathode terminals (pins No. 3 and No. 6), as well as the ground side of all bypass condensers, should be connected directly to this common ground.

The plate line is made of two pieces of ½-inch copper tubing. Both the plate line and the antenna coupling loop are mounted on a Polystyrene block bolted to the end of the chassis. It is possible to use a metal plate to support the plate line, because the shorted end of the line is at approximately ground potential for r-f, and because the whole line is insulated from the d-c plate voltage. If the metal plate is used, feed-through insulators can be used to support the coupling loop.

Safety Measure Real Feature

Insulation of the plate line from the d-c plate voltage will help to prevent many a nasty shock when the transmitter is adjusted and tuned. This feature can easily be arranged by feeding the plate voltage to the plates of the 815 by means of the insulated wires passed through the center of the copper tubing. R-f coupling between the 815 plates and the plate line is improved by installing condensers C_6 and C_7 . These condensers are made by wrapping and bolting a piece of one-inch copper strip around each plate rod at

(Continued on page 3, column 1)



BOTTOM VIEW OF 815 OSCILLATOR/XMTR

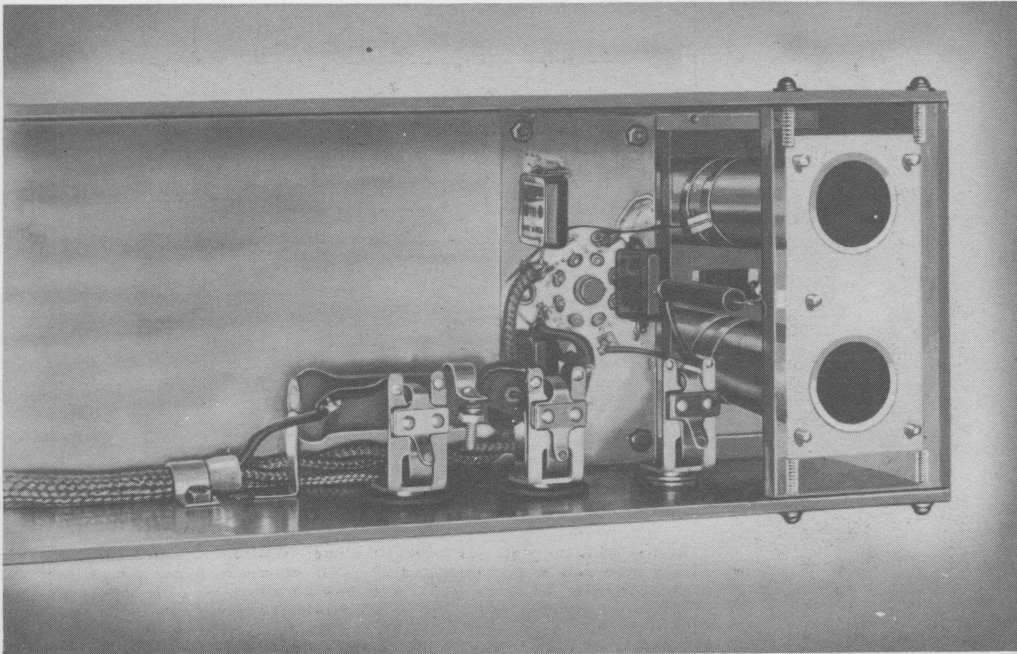

Simplicity and solid construction are the keynote of this equipment. The oscillator may be modulated up to 80 per cent with good linearity. It requires 16 to 19 watts of a-f power to do the job. A pair of 6L6's in p-p class AB₁ will deliver this power.

Low-Cost P-P Beam Tube Finds Multitude of Ham XMTR Uses

(Continued from page 2, column 4)

the plate end. Mica, 0.002 inch thick, is used to insulate the copper strip from the rod.

Before the 815 oscillator is actually tested, it is important that the meter leads be adequately shielded. About 4 feet of rubber-covered, shielded microphone cable, with a shielded microphone plug such as the Ampenol #MCIF, can be used for this purpose. In addition to this shielding, a 0.005 μ f mica condenser should be connected directly across the meter terminals. A rubber boot should be used to protect misguided fingers from the exposed metal of the jack, since both the plate and screen jacks are "hot."

Ready to Tune and Adjust

When the 815 oscillator unit is ready to be tested, it is advisable to use a 2000-ohm, 50-watt protective resistor in the -B lead until the proper circuit adjustments have been made. In adjusting the grid circuit, it will be found that the grid line will tune to 112 Mc when the spacing of C₁ is about $\frac{3}{8}$ inch for the dimensions given. With a 0-25 ma. meter plugged into the grid jack, the plate condenser, C₅, should be tuned until about 3 to 5 ma. of grid current flows. This condition indicates oscillation. The protective resistor can now be removed and the antenna feeders connected to the coupling loop. C₅ should be tuned slightly on the inductive (low capacitance) side of

600-Mc OSCILLATOR USING MIDGET TRIODE 9002

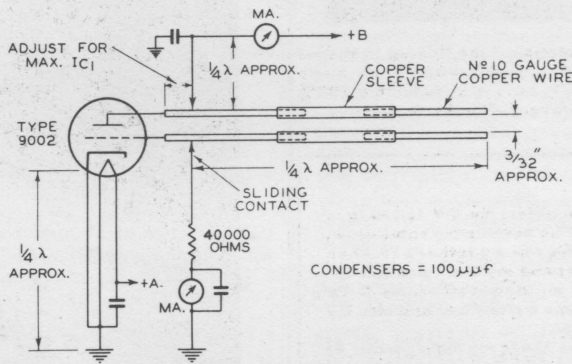

minimum plate current in order to insure sufficient grid current.

The loading can be increased by gradually bending the coupling loop closer to the plate line, until a plate current of 150 ma. flows, with C₅ tuned to resonance. The screen current should be about 15 ma., and the grid current about 3 ma. With these adjustments, the power delivered into the antenna feeders is about 27 watts for CCS conditions, and 34 watts for ICAS conditions—class C telephony.

For class C telephony service, it is possible to modulate the 815 oscillator 80% with good linearity. Beyond this, the negative peaks are cut off, due to the tube dropping out of oscillation. About 16 watts of modulating power is required for the CCS conditions, and 19 watts for the ICAS conditions. This amount of power can readily be supplied by two 6L6's operated in push-pull class AB₁.

Midget Tubes Enjoy Wide Approval by Hams and Engineers

(Continued from page 1, column 2)

lead inductance be low. In the Midget tubes, as in the Acorn tubes, the transit time is decreased by bringing the cathode, grids and plate close together. The interelectrode capacitances are decreased by using small cathodes, grids and plates. Short, internal leads and low lead inductance are insured through the use of the glass-button stem structure and the single-ended design. Each tube has two cathode leads. These leads may be used in parallel, or as separate returns for input and output circuits, in order to reduce the common feedback inductance. The triode 9002 also is designed with two plate leads.

In application, the Midget tubes may be used in uhf equipment the same way that ordinary tubes are used in standard broadcast receiver application. For example, a typical short-wave receiver might employ 9001's or 9003's in the r-f system as r-f amplifier and mixer. The 9002 could be used as the oscillator. The choice of the sharp or the remote cut-off pentode as r-f amplifier or mixer will depend on the range of signal strengths which it is desired to handle. In the i-f stages, 9001's or 9003's could be used when the i-f frequency is above 100 Mc. The Midgets may also be used in other applications, such as resistance-coupled audio amplifiers and biased detectors, particularly when there are limits on space and weight. The circuit on this page shows the 9002 employed as an oscillator. Under the conditions given, the oscillator will perform smoothly at frequencies as high as 600 Mc with a plate input of 1.6 watts! It is designed for use with tuned grid and plate lines $\frac{1}{4}$ -wave long. Complete technical information on the 9001, 9002 and 9003 may be obtained by writing to the Commercial Engineering Section, RCA Manufacturing Company, Harrison, N. J.

SHIP-SHAPE GEAR FROM STEM TO STERN

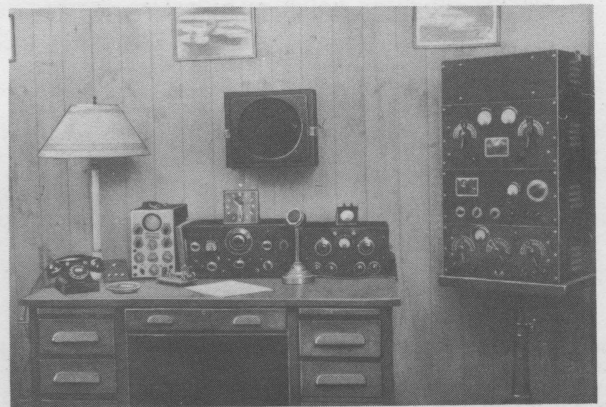

W3NT of Norfolk, Virginia, wins the five-spot for one of the neatest layouts we have seen in a long time. The business end of the station consists of two separate exciters. The final uses a pair of RCA-860 screen-grid types. Each exciter may also be used separately as a portable rig. Total tubes in transmitter amount to nearly thirty . . . and they are all RCA!

HAM TIPS from RCA

100% RCA WITH 808's IN FINAL



K7FST hits the jack pot with this prize-winning station. Tube line-up in the r-f section is 6L6 oscillator, 802 doubler, 807 buffer, and 2-808's final. Audio section ends up with a pair of 838's. Says K7FST, "I have always been a 100% RCA Tube user. They give you the biggest value ever." Thanks, Om.

STATIC

I married an OW, a widow with a grown daughter. My OM fell in love with my step-daughter and married her. Thus he became my son-in-law. My step-daughter became my maw because she was my father's YF. Then my OW gave birth to a young squirt who became my OM's brother-in-law and my uncle for he was the brother of my step-mother. My OM's YF gave birth to a son. This young squirt became my brother and also my grandchild for he was the son of my daughter.

Accordingly my YF is my grandmaw because she is my maw's maw. At the same time, I am my YF's husband and grandchild. And since a husband of one's grandmaw is his grandpaw, I am my own grandpaw.

W3EYM SUGGESTS NOVEL PILOT LAMP SYSTEM

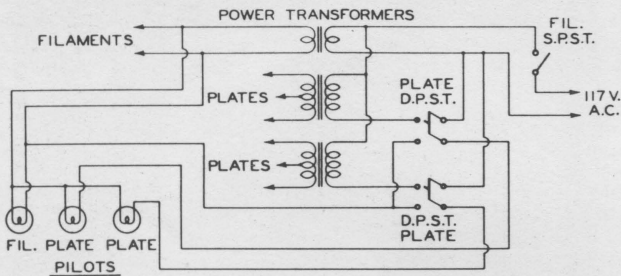

To connect 6.3-volt pilot lamps across a filament transformer winding is no trick. But to connect 6.3-volt pilot lamps in such a way as to indicate plate voltage too, is a trick. W3EYM ingeniously solved the problem by using D.P.S.T. switches in the primary of each plate-supply transformer. Actually the plate-voltage indicator pilots are connected across the filament transformer. One pole of the D.P.S.T. switch makes and breaks this circuit simultaneously with the other pole which makes and breaks the primary circuit of the transformer primary. It's a good wrinkle that nets W3EYM five smackers through the compliments of HAM TIPS.

R-F POWER AMPLIFIER USING RCA-8005

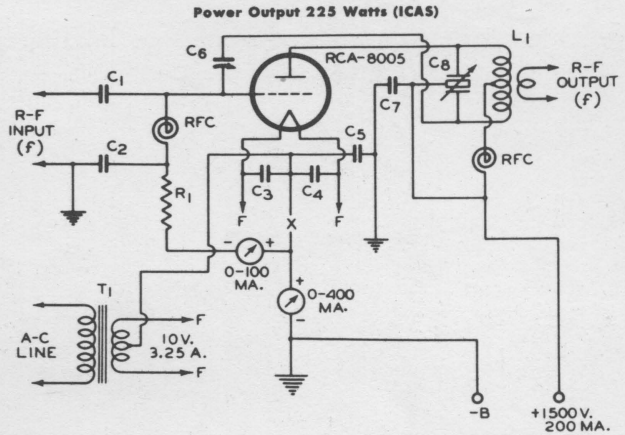

- C₁=0.0005 μf mica, 1000 v.
- C₂ C₃ C₄=0.005 μf, mica.
- C₅ C₇=0.002 μf, mica, 2500 v.
- C₆=5 μf (approx.) 6000 v.
- C₈=0.85 μf/meter/section, 2000 v.
- R₁=4000 ohms, 10 watts.
- RFC=R-F choke.
- X=Keying relay.

- T₁=Filament transformer.
- L₁=Tune to frequency "f".
- f=Operating frequency.
- NOTE: Rotor shaft of C₈ is at the high d-c plate potential. An insulated coupling shaft must be inserted between the rotor shaft of C₈ and its control dial.

RCA-8005 is the most powerful of the small triodes. It handles 300 watts input in a tube only 6 11/16" high and 2 7/16" in diameter. It has a maximum plate dissipation of 85 watts (ICAS) and may be operated with high plate-circuit efficiency at frequencies up to 60 Mc—at reduced ratings up to 100 Mc. Outstanding features of the tube are its Zirconium-coated plate, hard glass bulb, ceramic plate-cap insulator, metal shell base with ceramic insulation, and an extra-duty, 32.5-watt thoriated-tungsten filament.

POLARISCOPE

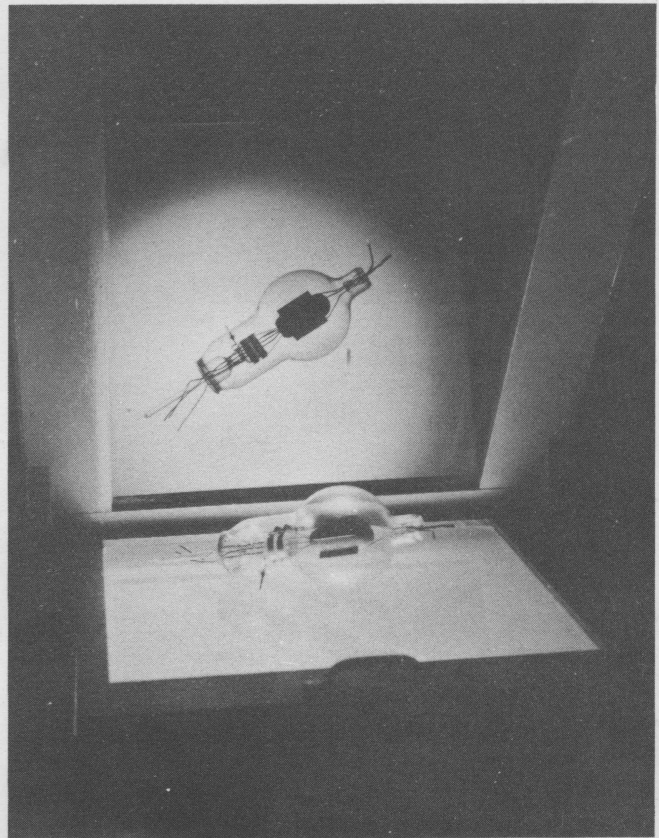

The tube structure has passed all exacting RCA tests, but what of its glass envelope? This polariscope tells the story. The slightest stress or strain in the glass becomes evident in the path of polarized light. By inspecting in this manner, the danger of leakage or breakage is eliminated—and engineering corrections can be made. As always, the aim is to supply you with tubes of unquestioned dependability in every physical and electrical characteristic.

The license extended to the purchaser of tubes appears in the License Notice accompanying them. Information contained herein is furnished without assuming any obligation.