

# HAM TIPS

from

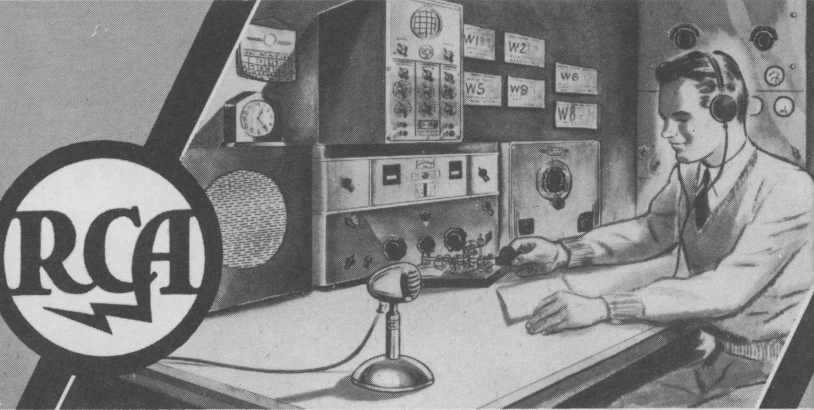

Published by RCA Manufacturing Company, Inc., Camden, N. J., U. S. A.

VOL. 5 — No. 1

CAMDEN, N. J.

JANUARY, 1942

## VFO GIVES 10 TO 25 WATTS OUTPUT FROM 10 TO 160 METERS:

### ENGINEERING HANDBOOKS

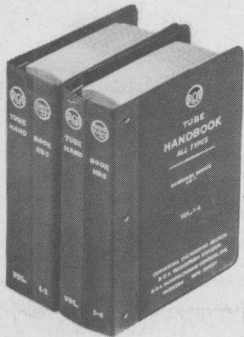

These loose-leaf volumes are the engineering authority on RCA tubes. They contain complete data and curves on all transmitting, receiving, cathode-ray, television, and special-purpose types. They are a real engineering guide and an essential reference for circuit designers.

### RCA TUBE HANDBOOKS INDISPENSABLE TO RADIO ENGINEERS

Contain Complete Technical Data  
And Curves for Designers

Little heard of in radio amateur circles but vastly important throughout the field of radio engineering are the RCA Tube All-Types HB-3 Handbooks. These loose-leaf volumes, bound in flexible fabricord binders, contain the most complete assembly of data and engineering curves on tubes of all types ever compiled. They cover transmitting tubes, cathode-ray tubes for television and oscillograph use, receiving tubes, phototubes, and special-purpose tubes such as the UHF Acorns and Midgets, Low-

(Continued on page 3, column 4)

### EXCITER DRIFTS LESS THAN 20 CYCLES PER HOUR AFTER 40-MINUTE WARM-UP PERIOD

### 802 ECO/807 Amplifier Unit Works Break-In With Clean-Cut Keying on All Bands

By R. B. Lincoln\*

#### DID YOU KNOW THAT . . .

The largest tube sold by RCA stands over five feet high and is capable of delivering 100,000 watts output . . . and that the smallest tube sold by RCA is only the size of an acorn and can handle an input of 1/4 to 1 1/2 watts.

Variable frequency oscillators and ECO's, signal spotters and QRM dodgers, up the band and down—comes a new signal and the channel goes jitterbug. Confusion? Most certainly not. It's the new technique of ham communication—shifting frequencies to increase the percentage of QSO's, saving time on calling and message handling, minimizing QRM.

Most simple way of obtaining instant frequency change in any given band is by means of a variable frequency oscillator, usually operated in conjunction with buffer/doubler stages to provide the desired output at the desired frequency. No subject in recent years has become more popular than that of the amateur VFO. A thousand and one articles have been written on a thousand and one versions of it. Most of the discussions are good, some are outstanding. As usual, none of the devices seemed to have all the features that seem important. Thus we set out to design and build an experimental VFO that had them—and we think we accomplished our aims.

#### Built for Maximum Stability

The variable frequency oscillator described in this article was built with a view to obtaining (1) maximum frequency stability, (2) break-in operation, (3) chirpless keying, (4) five-band operation, (5) high power output with a minimum of tubes, (6) wide bandspread on all bands, (7) high reset accuracy, and (8) a self-contained power supply. Since it was found that with reasonable care it was possible to reset this VFO within

(Continued on page 2, column 1)

\* Formerly of the Research and Engineering Dept., RCA Mfg. Co., Inc., Harrison, N. J.

### DELUXE 5-BAND VFO WITH HIGH-POWER OUTPUT

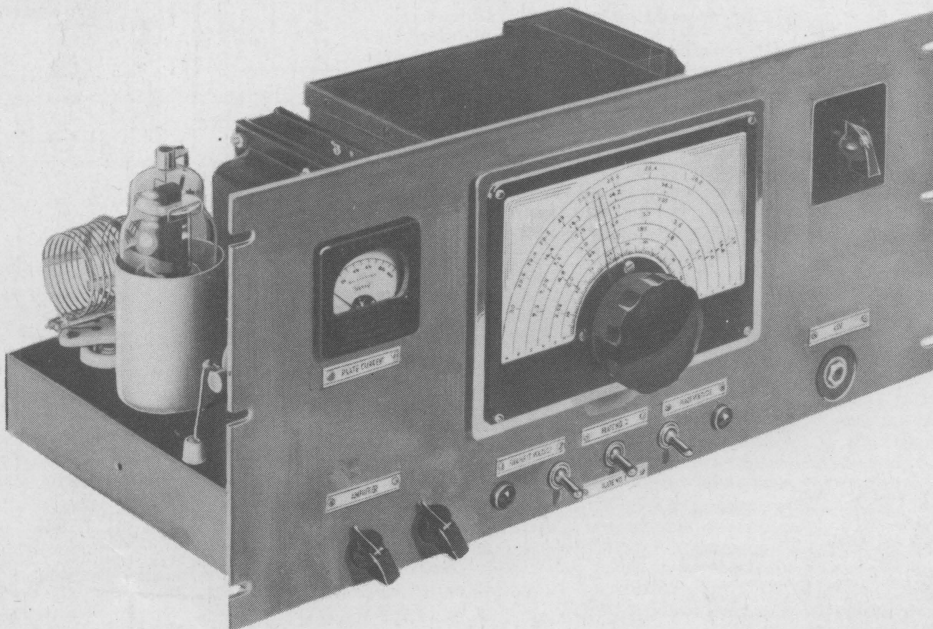

This thoroughly engineered VFO meets modern requirements for a master-control oscillator having exceptional frequency stability, break-in operation, chirpless keying, 5-band operation, high-power output, a minimum of tubes, wide bandspread on all bands, high dial-reset accuracy, and a self-contained power supply.

Copyright 1941, RCA Manufacturing Co., Inc.

## TOP VIEW OF DELUXE 5-BAND VFO

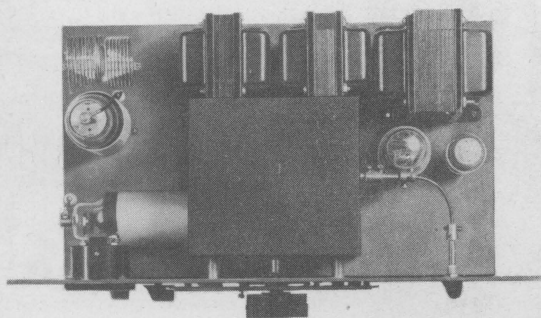

Simplicity and solid construction are key-notes of this instrument. The vital 802 control-grid circuit is enclosed in the central shield box. Note the dial-mounting arrangement and the extension of the 802 horizontally away from the box. The 807 buffer/doubler stage is rear left on the chassis, the power supply rear right.

### VFO Gives 10 to 25 Watts Output

(Continued from page 1, column 4)

a few hundred cycles (3.5-Mc band) of a marked point on the large band-spread dial—and do it consistently, no provision was made for the inclusion of crystals for spot-frequency operation.

### Uses 802 ECO at Reduced Ratings

A great many VFO's do their best work on but one or two bands. If small tubes are used, or if the fundamental frequency band (the band to which the frequency-controlling grid circuit is tuned) is relatively low, a string of doublers is required to reach the higher frequency bands. Moreover, the multiple doubling system provides very poor bandspread at the higher frequencies. On the other hand, if a higher fundamental grid-circuit frequency is used to obtain higher output and to improve the bandspread characteristic, then it often becomes necessary to forfeit operation on one or more of the low-frequency bands. Consequently, in this VFO it was decided to use the well-screened 802 as the electron-coupled oscillator and to operate it at greatly reduced ratings. Operation of the tube at reduced ratings minimizes frequency drift caused by slightly changing interelectrode capacitances while the tube heats up. Unquestionably, a receiving tube may also be operated as an oscillator to provide equally stable frequency characteristics. But by the time the input of the tube has been reduced sufficiently to obtain the desired stability, its useful output will have dropped nearly to the vanishing point. Then, an extra amplifier or so is required to make up the loss of power. The 802 in this VFO operates at a plate voltage of approximately 470 volts, at a screen voltage of 105 volts (regulated by a VR-75-30), and at a plate current of only 8 to 10 ma. Yet even at these low ratings the tube furnishes enough

power to drive an 807 operating as a buffer, doubler, or quadrupler to a fairly respectable output. And needless to say, the 802 runs very cool under these conditions. Frequency drift during warm-up periods is very small—about 400 cycles at 3.5 Mc.

### 807 Used as Buffer/Doubler

The 807 used in this VFO operates either as a buffer amplifier, doubler, and quadrupler depending on the frequency to which the ECO is tuned. The 807 operates at a d-c plate voltage of approximately 470 volts and a d-c plate current of 100

ma. at full load. D-c screen voltage is approximately 150 volts. Under these conditions, the 807 stage is capable of delivering to a lamp load a power output of approximately 5 watts at 10 meters to 25 watts at 160 meters—enough output to drive a pair of 812's to full output all the way down to 20 meters, and at reduced output to 10 meters. In fact, during these power output measurements it was found that with very careful adjustment it was possible to drive a second 807 on 5 meters!

### Grid Circuit Considerations

The circuit below shows that a bandswitching arrangement is provided for the 802 grid circuit and that switch  $S_1$  cuts in three different sets of pre-tuned grid-coil, trimmer, and padder combinations for practical 5-band operation having exceptional bandspread. This switching system has proven to be remarkably stable in practice; frequent use of it does not change the calibration of the VFO more than a few cycles. The lowest L/C ratio consistent with reasonable efficiency is used on all bands.

Lowest frequency chosen for use in the grid circuit of the 802 just takes in the low-frequency edge of the 160-meter band. Originally it was considered a possibility to use a fundamental frequency range lying within the standard broadcast band, but this was quickly dropped because of the ever-present possibility of caus-

ing interference in nearby broadcast receivers through-direct pick-up.

### 160- and 80-Meter Operation

When 160- or 80-meter output is desired from the VFO, the 802 grid circuit is tuned to 160 meters (1750 to 2050 kc) by means of  $C_{10}$ ,  $C_{11}$ ,  $C_{12}$ ,  $C_{13}$ , and  $L_3$ .  $C_{11}$  and  $C_{12}$  are zero-temperature-coefficient condensers. The plate circuit of the 802 is designed to resonate broadly on either 160 or 80 meters by means of a tapped coil  $L_5$ , which makes it possible to short out a portion of the inductance by means of switch  $S_2$  for 80-meter operation. A separate coil  $L_4$  is used for 20-meter output, which also is selected by means of  $S_2$ . This system of broadly tuning the plate circuit is similar in principle to the use of the untuned grid coil in the famous TNT oscillator circuit. Primary purpose of the broadly self-resonant plate circuit is to eliminate a tuning control. Secondary benefit is that it eliminates apparent reaction on the oscillator frequency caused by normal tuning adjustments in the oscillator plate circuit. While it is possible to use an ordinary r-f choke in the 802 plate circuit,  $L_4$  and  $L_5$  constructed in accordance with the specifications given in the legend of the circuit provide greater useful output and higher circuit efficiency. Output from the 802 is capacitively coupled to the 807 stage. Power output from the 807 at the desired frequency is dependent on the resonant frequency of

(Continued on page 3, column 1)

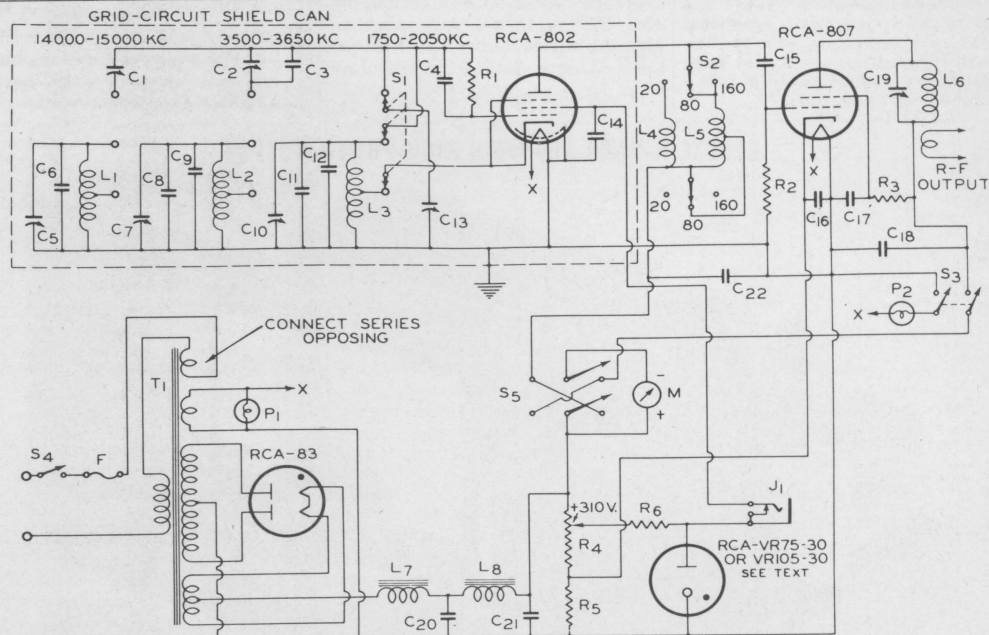

$C_1, C_2, C_3, C_7, C_{10} = 140 \mu\mu\text{f}$  air trimmers (Hammarlund APC-140).  
 $C_5, C_6 = 150 \mu\mu\text{f}$  zero-temperature coefficient. (Centralab).  
 $C_4, C_{15} = 250 \mu\mu\text{f}$  mica.  
 $C_8, C_{11} = 350 \mu\mu\text{f}$ , zero-temperature coefficient.  
 $C_9 = 250 \mu\mu\text{f}$ , zero-temperature coefficient.  
 $C_{12} = 300 \mu\mu\text{f}$ , zero-temperature coefficient.  
 $C_{13} = 40 \mu\mu\text{f}$  (min.) to  $395 \mu\mu\text{f}$  (max.) main tuning condenser (Hammarlund APC-350-C).  
 $C_{14} = 0.001$  mica.  
 $C_{16}, C_{17}, C_{18} = 0.01 \mu\text{f}$  paper, 600 v.  
 $C_{19} = 100 \mu\mu\text{f}$  variable (Cardwell ZU-100-AS).  
 $C_{20}, C_{21} = "8-8 \mu\text{f}$  Replacement (Cornell-Dublier #PE-B).

$J_1 =$  Keying Jack.  
 $L_1 = 6$  turns of #16 en. wire on  $\frac{1}{2}"$  form, winding length  $\frac{3}{8}"$  in.  
 $L_2 = 23$  t, #16 en. wire on  $\frac{1}{2}"$  form, close wound.  
 $L_3 = 33$  t, #18 DCC wire on  $1"$  form, close wound.  
 $L_4 = 7$  t, #16 en. wire on  $\frac{3}{4}"$  form, winding  $\frac{3}{4}"$  long.  
 $L_5 = 110$  t, #30 en. wire on  $1"$  form, tapped at 71 turns; close wound.  
 $L_6 = B. \& W.$  coils. (See table.)  
 $L_7 = 8-35$  henry, 200 ma, choke (Stancor C-1645).  
 $L_8 = 20$  henry, 200-ma. choke (Stancor C-1646)

$P_1, P_2 = 6.3$ -volt pilot lights ( $\frac{1}{2}$  inch).  
 $R_1, R_2 = 25,000$  ohms, 1 w.  
 $R_3 = 17,500$  ohms, 2 watt.  
 $R_4 = 15,000$  ohms, 50 watt slider.  
 $R_5 = 250$  ohms, 10 watt.  
 $R_6 = 10,000$  ohms, 10 watt.  
 $S_1 =$  TPPT rotary ceramic switch.  
 $S_2 =$  DPST rotary switch.  
 $S_3 =$  DPST toggle switch.  
 $S_4 =$  SPST toggle switch.  
 $S_5 =$  DPDT toggle switch.  
 $T_1 = 600$ -0-600 volt, 200 ma. power transformer (Stancor P-6170).  
 $M = 0-150$  ma, 2" square meter (Triplett or Simpson).

## VFO Gives 10 to 25 Watts Output

(Continued from page 2, column 4)

L<sub>6</sub> C<sub>19</sub>. L<sub>6</sub> is of the plug-in variety.

### 40- and 20-Meter Operation

For 40-meter operation, S<sub>1</sub> is set to include the 80-meter grid circuit of the 802. This circuit includes L<sub>2</sub>, C<sub>2</sub>, C<sub>3</sub>, C<sub>7</sub>, C<sub>8</sub>, C<sub>9</sub> and C<sub>13</sub>. C<sub>2</sub> and C<sub>3</sub> are series padding condensers, used for bandspread over the range of 10 to 90 on the dial. S<sub>2</sub> is set to short out a portion of L<sub>5</sub> so that 80-meter output will be obtained from the 802 plate circuit. The 807 is operated as a 40-meter doubler. Power sensitivity of the 807 is so high that nearly as much output is obtained at this frequency as is obtained on the two lower frequency bands.

For 20-meter operation, S<sub>1</sub> and S<sub>2</sub> are set the same as for 40-meter operation. The 807 is operated as a frequency quadrupler. Output is still sufficient to drive a pair of 812's in push-pull to full power output on 20 meters. Bandspread on this band is approximately 2/3 that on 40 meters—which is, incidentally, still real bandspread!

For 10-meter output, S<sub>1</sub> is set to include the 802 20-meter grid circuit C<sub>1</sub>, C<sub>5</sub>, C<sub>6</sub>, and L<sub>1</sub>. C<sub>6</sub> is a zero-temperature-coefficient condenser. S<sub>2</sub> is set to include L<sub>4</sub>, tuned to resonate the 802 plate circuit broadly on 20 meters. The 807 is operated as a 10-meter doubler. Bandspread on the 10-meter band covers 10 to 90 on the ACN dial—as much bandspread as on 40 meters.

### Frequency Stability Considerations

Sturdy mechanical construction, proper layout of components to minimize temperature rise in critical tuned circuits, high-quality parts, good voltage regulation, and the proper use of sufficient zero-temperature-coefficient condensers are the essentials of a well-performing ECO. If these important factors are considered from the start, the results are almost always bound to be satisfactory.

As can be noted from the general views of the VFO, chassis and panel design is conventional. Choice of dimensions may be left completely to individual needs. In our case, we chose a chassis, 17" long x 10" wide x 2" deep, and a panel 19" long x 8 3/4" high x 1/8" thick. This combination provided the necessary solid foundation for the job. It is interesting to note here that on final tests of the VFO, we endeavored to check the solid construction by raising one corner of the chassis about 2 inches and then dropping it. On checking the frequency shift during this torque/drop test, it was found that the frequency had varied about 30 cycles. Part of this shift was undoubtedly caused by a change in rotor position of the tuning condenser. So much then for solid chassis construction.

## 802 CONTROL-GRID CIRCUIT IS VITAL

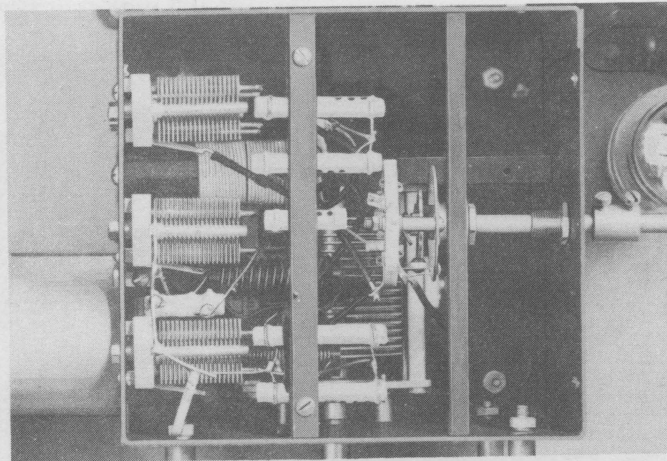

The 802 grid circuit and its associated shield enclosure is the most important unit of the VFO. The five air-padders C<sub>1</sub>, C<sub>2</sub>, C<sub>5</sub>, C<sub>7</sub> and C<sub>10</sub> and the three grid coils L<sub>1</sub>, L<sub>2</sub> and L<sub>3</sub>, are mounted on the left side of the box. C<sub>13</sub> and the dial mounting arrangement are seen in the center of the box. Note the position of the five zero-coefficient condensers at the top of the assembly.

### Isolating Grid Circuit from Heat

A bug-bear in the design of ECO's is the problem of heat caused by normal operation of circuit components. This heat nearly always affects the frequency characteristic of the critical-tuned oscillator grid circuit and results in frequency drift. In this VFO, the effective temperature rise of the all-important grid-circuit components has been limited by grouping the grid-circuit components together in one shield can (as shown above) and by isolating this can as far as possible, from all high heat-dissipating units such as transformers, tubes, and bleeder resistors. In this case, the grid-circuit shield can is but 5 1/2" x 6" x 5 1/2" in size. Only heat-dissipating element in the can is R<sub>1</sub>, the 802 grid leak, which may be considered negligible since the grid current flowing through the grid circuit is unusually small. The 802 tube itself is mounted to the left of the shield can so that the tube projects horizontally away from the can (top view, page 2). Thus, the tube is well ventilated—and, what is more important, its heat does not affect the tuned circuits within the can. As added precautions to minimize the amount of heat reaching the all-important oscillator grid circuit, the 807, power transformers, rectifier tube, and filter chokes are mounted along the rear and side edges of the chassis so that they are well ventilated and are as far removed from the grid-circuit shield can as is possible.

### Screen-Supply Voltage Regulated

The stability of the d-c screen voltage of an oscillator designed primarily for constant frequency output is of great importance. The use of a voltage divider for supplying a fixed value of screen voltage is of help but is not sufficient for maximum stability. For this reason, a voltage-regulator tube is used in the screen-voltage supply of

the 802. It irons out effects caused by line-voltage variation and reduces oscillator hum. It is particularly helpful in eliminating chirps in the output when the oscillator is keyed—and keying is a feature of this VFO.

### Temperature Compensation

All of the foregoing features are vital to a smooth performing and stable VFO, but the final results are incomplete without the application of temperature compensation to offset the change in frequency caused by whatever heat does reach the vital 802 grid circuit. Judicious use of zero-temperature-coefficient capacitors in parallel with the three grid-tank circuits of the oscillator do much to give the oscillator its exceptionally low frequency drift. These capacitors are not a cure-all but they do come into their own where frequency drift is due to reasonably small amounts of heat. These capacitors are mounted within the grid shield can and their installation will be covered later on.

### Assembling the Vital Grid Circuit

The 802 grid circuit and its associated shield enclosure is the most important unit of the VFO and its construction and placement should be the first consideration in the construction of the instrument. The shield box is 5 1/2" x 6" x 5 1/2" and has a removable top and bottom. The five air padders C<sub>1</sub>, C<sub>2</sub>, C<sub>5</sub>, C<sub>7</sub>, and C<sub>10</sub>, and the three grid coils L<sub>1</sub>, L<sub>2</sub>, and L<sub>3</sub> are mounted on the left side of the box. Dimensions of L<sub>1</sub>, L<sub>2</sub>, and L<sub>3</sub> are given in the circuit legend on page 2. The coils are mounted end-on by means of 6-32 spade lugs. C<sub>13</sub>, the main tuning condenser, is held in place by three sets of mounting screws and studs furnished with it for front mounting. The back of C<sub>13</sub> is held in place by a strip of 1/2" Bakelite, 2 1/2" wide and 6" long, solidly bolted to the opposite sides of the box. The zero-coefficient

## RCA Tube Handbooks Indispensable to Engineers

(Continued from page 1, column 2)

Microphonic tubes, Gas-Triodes, and Gas-Tetrodes. For example, data on any particular tube type include its intended use, maximum ratings, characteristics, typical operating conditions, physical dimensions, terminal or socket connections and its most commonly used characteristic curves. These curves are plotted to easily readable scales and large enough for solving of design problems.

In addition to the above information, HB-3 Handbooks contain a valuable storehouse of general information on radio tube definitions, base dimensions, types of cathodes, conversion factors, outline drawings, resistance-coupled charts, etc. RCA All-Types Handbooks are available either in two 4-prong binders marked Vol. 1-2 and Vol. 3-4 (as illustrated) or in three 6-ring binders marked Vol. 1, Vol. 2, and Vol. 3. Subscription price for either style is \$6.00, which includes cost of service for one year.

For those who require information only on receiving tube types, there is available the HB-1 Handbook which contains the first section of the HB-3. The HB-1 is available either in one 4-prong binder at \$3.75, or in two 6-ring binders at \$4.00. These prices include cost of service for one year. All binders of both the HB-1 and the HB-3 are furnished in black fabric, 7 3/8" high by 5" wide.

Prices quoted above apply only in the U. S. A. and its possessions.

All inquiries and orders for Handbooks should be sent to the Commercial Engineering Section, RCA Manufacturing Co., Inc., Harrison, N. J.

condensers are rigidly held between two additional Bakelite strips. These two strips should first be clamped together and drilled with holes large enough to accommodate the zero-coefficient condensers. The strips should then be separated and the condensers inserted. Since these condensers are in the form of rather fragile ceramic tubing it is suggested that they be wrapped with several turns of rubber tape to reduce the danger of cracking them. This cushioning also aids in damping any possible vibration. The Bakelite mounting strips are then clamped together and bolted to opposite sides of the grid box, as shown in the figure above. They serve a further purpose by acting as cross-braces to increase the rigidity of the box and of the parts mounted on it.

### Mounting Bandswitch S<sub>1</sub>

Bandswitch S<sub>1</sub> is mounted on the right side of the grid circuit shield box. It is held in place by means of a third Bakelite cross-brace. S<sub>1</sub> selects the critical-tuned grid circuits and its

(Continued on page 4, column 1)

# HAM TIPS from RCA

## VFO Gives 10 to 25 Watts Output

(Continued from page 3, column 4)

importance cannot be overestimated. It should be of good quality and be designed with ceramic insulation.  $S_1$  is controlled from the front panel by means of a short, flexible shaft which must make a right-angle bend. There is no need to be alarmed about the small amount of backlash originating in the cable because the switch contacts are spaced  $30^\circ$  apart. As mentioned earlier, the 802 is mounted on the lower left side of the shield can. The entire shield-can assembly with the 802 on the side, is then mounted to the chassis by means of four live-rubber washer assemblies. These washers have excellent shock-absorbing qualities. It can now be seen that with this arrangement, mounting the tuning dial rigidly to the panel in usual constructional practice would require the use of a flexible coupling between dial and  $C_{13}$  to preserve the mechanical shock-proof qualities of the live-rubber mountings. But the use of a flexible coupling is undesirable because it will introduce backlash and moreover may not have an exact 1:1 ratio should the shield box become displaced slightly from its normal position.

### Tuning Dial is Important

To overcome the above effect, a National ACN was chosen for the tuning control. It has remarkable freedom from backlash and includes a built-in, semi-flexible coupling device which compensates for minor mis-alignment of dial or condenser.

All parts are mounted on a 17" x 10" x 2" chassis. Proper layout of components, high-quality parts, good voltage regulation, and correct use of zero-temperature coefficient condensers, contribute to the remarkable performance of this VFO. The 802 plate coils  $L_4$  and  $L_5$  are located in the upper left corner.  $L_5$  consists of 110 close-wound turns of #30 enamelled wire on a 1" form and tapped at 71 turns.  $L_4$  consists of 7 turns of #16 enamelled wire on a  $\frac{3}{4}$ " form. Winding is  $\frac{3}{4}$ " long.

The ACN dial permits mounting of the tuning control directly on the grid-circuit shield can so that the whole assembly including the dial is free to float. (While on the subject of backlash, it might be timely to touch on the subject of an insidious type of backlash which shows up in some types of double-bearing condensers. This backlash is caused by the tendency of the back end of the rotor shaft to hop up and down in its bearing when the rotor is "inched" first one way and then the other. It is well to look very closely for this defect in a condenser used as the grid-circuit tuning control in any ECO. This defect, of course, will cause no trouble in amplifier circuits.) The white cardboard dial itself is

fastened to a sheet-metal backing plate which in turn is mounted solidly to the shield can by means of four  $\frac{3}{8}$ " metal studs. These studs are made about 1" long to permit the dial to be placed about  $\frac{1}{4}$ " in front of the main VFO panel and the grid-circuit shield box about  $\frac{5}{8}$ " behind the VFO panel. Clearance holes are made in the VFO panel to allow for suitable clearance of the studs. The studs are drilled and tapped at each end for 6-32 or 8-32 screws. The dial-backing plate is fastened to the studs by means of countersunk screws to permit a snug fit of the dial against the plate. Four  $\frac{5}{16}$ " holes are drilled through the panel behind the dial to clear the mounting studs, and a  $2\frac{1}{2}$ " hole should be made around the condenser shaft center to clear the dial mechanism. With this arrangement it is possible to bump the chassis or operating table without causing appreciable frequency wobble.

In the actual assembly and wiring of the grid shield box, the layout of the large parts should first be determined. Then the ACN dial and  $C_{13}$  should be mounted on the shield box and the positions of the panel holes behind the dial determined. The bottom cover of the can may be mounted by means of the four rubber washer assemblies. The dial and  $C_{13}$  should next be removed from the shield can and with both covers removed from the can, all holes should be drilled, all parts mounted, and all wiring completed. A small "pencil" type soldering iron will prove useful in the wiring of this unit.

Long, flexible leads should be soldered to the 802 socket while the shield can is out in the open. These leads can then be threaded through grommets holes in the bottom shield cover and the chassis before replacing the shield can of the tube. Several inches of slack should be left in these power leads so that the grid-circuit shield box can be tipped up on edge for servicing later, if desired. A small feed-through insulator is used to run the 802 plate lead through the chassis. The 802 plate coils  $L_4$  and  $L_5$

and bandswitch  $S_2$  are mounted beneath the chassis for added shielding. Dimensions of  $L_4$  and  $L_5$  are given in the legend of the circuit on page 2.  $S_2$  is a double-pole, triple-throw rotary switch.

### Laying Out the 807 Stage

As can be seen from the illustrations, layout of the 807 is comparatively simple. Plug-in plate coils are used in this stage. The socket for the plate coil,  $L_6$ , is mounted above the chassis for convenience in changing coils. Tuning condenser  $C_{19}$  is mounted on a bracket beneath the chassis and is connected by a long insulated extension shaft to a control knob on the front panel. The 807 is capacitatively coupled to the 802 through  $C_{15}$ . The plate lead of the tube is run through a feed-through insulator to the tank circuit below the chassis.

### Power Supply is Simple

An inexpensive 600-0-600 volt power transformer and an 83 mercury-vapor rectifier supply all voltages for the VFO. A double-section filter system is used.  $L_7$  is of the swinging type.  $L_8$  is a standard fixed type. Regulation of the power supply is excellent. The 83 with its low voltage drop,  $L_7$  and  $L_8$  with their reasonably low d-c resistance, and the swinging properties of  $L_7$  all tend to compensate for variations in load. Output ripple voltage of the supply is very low. This fact is important in any ECO.

At this point it should be called to the attention of the constructor that the extra 6.3-volt filament winding on the power transformer is connected in series with the primary of the transformer so that the high secondary voltage is reduced to 550-0-550. This is done to prevent application of excessive voltage to the 83. A tap on bleeder resistor  $R_4$  permits adjustment of the VR-75-30 voltage regulator tube so that it draws about 25 ma. under key-up conditions. A d-c milliammeter may be inserted at "x" during this screen-circuit voltage adjustment. In actual tests, it has been found that use of a VR-75-30 gives more 807 output from 160 to 20 meters than when the 802 screen is operated at a higher voltage with a VR-105-30. Moreover, the use of the higher screen voltage doubles the 802 plate current and increases frequency drift during warm-up periods.

### Aligning and Calibrating

This VFO may be considered a precision instrument and as such is deserving of accurate calibration. A frequency standard, such as the RCA type TMV-133A Crystal Oscillator,

(Continued on page 5, column 1)

## BOTTOM VIEW OF DELUXE 5-BAND VFO

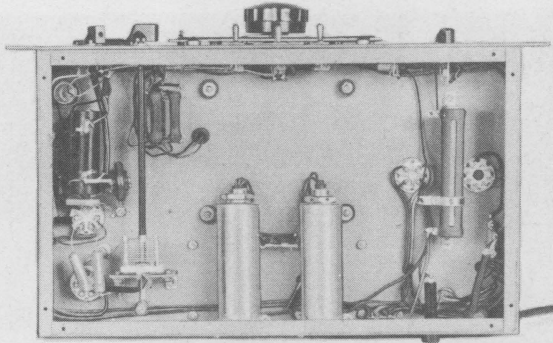

All parts are mounted on a 17" x 10" x 2" chassis. Proper layout of components, high-quality parts, good voltage regulation, and correct use of zero-temperature coefficient condensers, contribute to the remarkable performance of this VFO. The 802 plate coils  $L_4$  and  $L_5$  are located in the upper left corner.  $L_5$  consists of 110 close-wound turns of #30 enamelled wire on a 1" form and tapped at 71 turns.  $L_4$  consists of 7 turns of #16 enamelled wire on a  $\frac{3}{4}$ " form. Winding is  $\frac{3}{4}$ " long.

## GIANT BAND-SPREAD DIAL PERMITS ACCURATE RESET

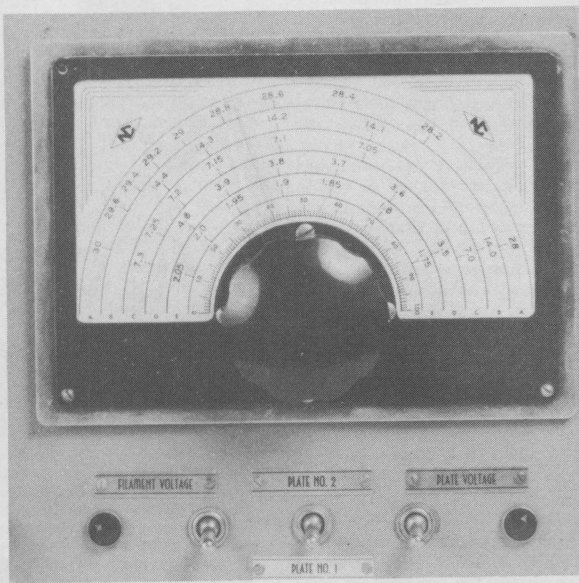

Bandspread extends from approximately  $120^\circ$  on 20 and 80 meters, to  $145^\circ$  on 10 meters. Tests show that it is practical to reset the frequency within a few hundred cycles of a marked point on 80 meters. For this reason, no provision was made for inclusion of crystals for spot-frequency operation.

### DID YOU KNOW THAT . . .

WCFT, the schooner Yankee, maintained round-the-world communication using an RCA-803 325-watt transmitting pentode during its cruise in 1939-1941? Circuit used was an E.C.O. on 18, 24, 27, 36 and 600 meters.

## VFO Gives 10 to 25 Watts Output

(Continued from page 4, column 4)

is invaluable for aligning and calibrating it. The TMV-133A provides usable harmonics every 100 kc. up to 30 Mc. In lieu of such a frequency standard, an accurately calibrated receiver, or a receiver operated in conjunction with a well-built, home-constructed 100-kc. oscillator that is calibrated against a local broadcast station, will be satisfactory.

First, the 802 grid circuit should be adjusted. Plate and screen voltage of the 807 should be removed by leaving  $S_3$  open. Set  $S_1$  to "160" and adjust  $C_{10}$  with a screwdriver so that the oscillator output tunes exactly to 1900 kc. with  $C_{13}$  set at "50" on the dial. If the band will not center, use a larger or smaller value of  $C_{11}$ . Should the dial not cover the complete range from 1750 to 2050 kc., remove one or two turns from  $L_3$  and add to  $C_{10}$ ,  $C_{11}$  or  $C_{12}$  as needed. This completes the calibration for 160 meters and since this grid tank circuit is also used on 80 meters by doubling in the plate circuit, the calibration is also completed for 80 meters.

Second operation is to calibrate the 802 grid circuit operation on 40 meters. Set  $S_2$  to the "80" position and adjust  $C_7$  so that the second harmonic of the oscillator tunes exactly to 7300 with  $C_{13}$  set at "10" (near minimum). Next, turn  $C_{13}$  to read "90" on the dial (near maximum) and adjust  $C_2$  so that the oscillator just hits 3500 kc. This completes the calibration for 40 meter, and since the 80-meter grid tank circuit is also used by quadrupling in the plate circuit, the calibration is also completed for 20-meter operation.

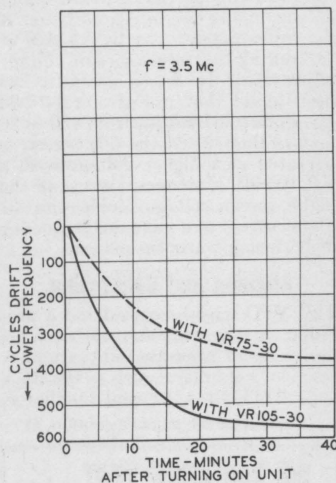

### VFO Frequency Drift Characteristics

Third operation is to calibrate the 802 grid circuit for operation on 10 meters. Set  $S_2$  to "20" and adjust

## W6RTO BUILDS 807 RIG IN VIRTUAL SHOW WINDOW

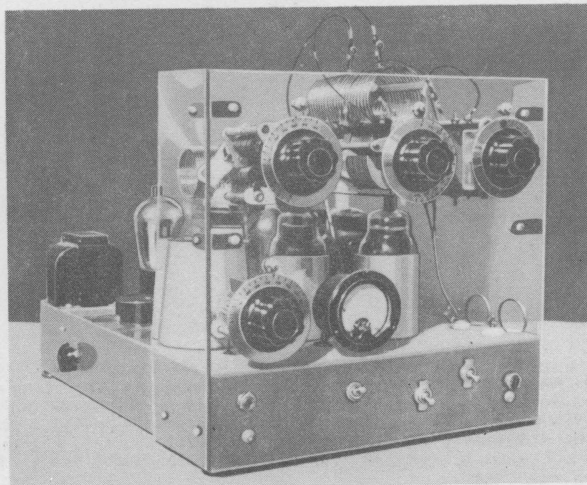

The \$5.00 prize goes to F. L. Moore, of Moffett Field, Calif., for a picture of his most novel transmitter. The rig uses a 6L6 crystal oscillator and two 807's in parallel at 120 watts input. It is built in one complete unit with self-contained power supply and an antenna coupler to match any type of radiator. No need for further details, we see right through it (!?)

$C_5$  so the second harmonic of the oscillator tunes exactly to 28,000 kc. with  $C_{13}$  set at "90." Output on 10 meters is obtained by doubling in the 802 plate circuit.

After the 802 grid circuit has been aligned, plate coil  $L_5$  should be adjusted to give 3 to 5 ma. grid current when  $S_1$  and  $S_2$  together are set at "80" or "160."  $L_4$  should then be adjusted to give 1 to 2 ma. when  $S_1$  and  $S_2$  together are set at "20." Grid current can be measured by opening the ground end of  $R_2$  and inserting an 0-5 or 0-10 d-c milliammeter in the 807 grid circuit. The opened end of  $R_2$  should be by-passed for r.f. to the chassis during the measurement to maintain a short r-f grid circuit return. As discussed earlier, the 807 is protected during key-up conditions by the semi-fixed bias voltage provided by the sum of the 807 cathode current and the bleeder current developed across  $R_5$ . Dimensions for  $L_6$  are given in Table I, page 6.

### Keying is Crisp and Clean-Cut

Keying of this VFO is done in the oscillator circuit for break-in operation. Oscillation is completely cut off by keying the 802 screen voltage, between the 802 and the voltage-regulator tube. It is important to note that keying of the screen voltage should not be accomplished between the voltage-regulator tube and the negative side of the voltage supply as shown by "X" in the circuit for this method will produce very bad keying transients. With the circuit shown, keying is clean and crisp and any slight key clicks resulting from making and breaking this low-current circuit can readily be eliminated by means of a simple resistance-capacitance filter across  $J_1$  for normally closed circuit. Plug for  $J_1$  may be wired to a key, switch, or relay contact, as desired. For listening,

$S_3$  and  $J_1$  are normally open. To "spot" a desired station, close  $J_1$  and swing  $C_{13}$  to zero beat with the desired incoming signal. Then flip  $S_3$  to "on" when ready to transmit.

### How VFO Performs

The curves on this page show the number of cycles the 802 control grid circuit drifts from a cold start when operating at 3.5 Mc. Note that, when using a VR-75-30 regulator in the screen circuit of the 802, the overall drift is less than 400 cycles and that practically all of this drift occurs within the first 30 minutes of operation. Moreover, after the first 10 minutes of operation, the oscillator drifts only about 150 cycles. When a VR-105-30 is used in place of the VR-75-30, the drift increases, but the results are still exceptional. Various tests were made to check mechanical and electrical stability. When the oscillator grid box was jarred, bumped or twisted, it was found that the signal always returned to within about  $\pm 5$  cycles of its original frequency. It was found that wrapping the bulb of the 802 bulb with several turns of rubber tape aided stability by preventing tube movement within its shield can. A test was made on the practicability of using the band-switching 802 grid circuit.  $S_1$  was rapidly flipped over 30 times in succession. On checking the frequency change after this check, it was found that the total frequency drift was less than 10 cycles! In a careful check of the stability and accuracy of the instrument, it was found that the oscillator could be reset to a few parts in a hundred thousand. Measured power output from the 807 was approximately 25 watts on 160 meters, 20 watts on 80 meters, 15 watts on 40 and 20 meters and 5 watts on 10 meters. Either capacitive or link coupling may be used to

the following stage. When capacitive coupling is used, the length of the interstage coupling lead should be as short as possible. When link coupling is used, losses incurred in the impedance line are not appreciable up to approximately four feet. If it is desired to drive a beam tube, such as an 828 or an 813, it is recommended that a potentiometer be used in place of the 807 screen series resistor in order to reduce the 807 output by controlling the 807 screen voltage.

From the foregoing description, it can readily be seen that this VFO can be built as a precision instrument. As such, it should be treated carefully to provide the constructor with the utmost in performance. It will save the operator invaluable time in station operation and add greatly to the ease and pleasure of getting the most out of every QSO. The author wishes to express his sincere appreciation to Messrs. A. G. Nekut, E. E. Spitzer, and R. S. Burnap of the Radiotron Division for their invaluable assistance in the designing, building and testing of this unusual instrument.

### Appendix

Tuning-condenser values for an ECO designed to have approximately 100% bandwidth may be calculated as follows:

For a given total maximum capacitance ( $C_{max}$ ), the net capacitance variation ( $K$ ) required to give 100% coverage from a low-frequency limit ( $f_{low}$ ) to a high-frequency limit ( $f_{high}$ ) can be calculated from the following relation:

$$K = C_{max} \left[ 1 - \left( \frac{f_{low}}{f_{high}} \right)^2 \right]$$

As an example, for the "160" grid-circuit position, assume  $C_{max} = 1185 \mu\mu\text{f}$ ,  $f_{low} = 1750 \text{ kc.}$ , and  $f_{high} = 2050 \text{ kc.}$  Therefore,

$$K = 1185 \left[ 1 - \left( \frac{1750}{2050} \right)^2 \right] = 324 \mu\mu\text{f}$$

For a variable condenser having a total maximum capacitance of 395  $\mu\mu\text{f}$ , the total shunt padder capacitance should be  $1185 - 395 = 790 \mu\mu\text{f}$  which equals the sum of  $C_{10}$ ,  $C_{11}$ ,  $C_{12}$ , and stray capacitances. See Fig. 2.

If, for example, a tuning condenser having a maximum capacitance of (say) 500  $\mu\mu\text{f}$ , and a minimum capacitance of (say) 50  $\mu\mu\text{f}$  is used, the total  $K$  is  $500 - 50 \mu\mu\text{f} = K$ . For calculation purposes,  $K$  can be treated approximately as a fixed capacitance. Using the well-known series-condenser relations we obtain:

(Continued on page 6, column 1)

### BOOK OF THE HOUR

The RCA GUIDE for Transmitting Tubes is the finest and most complete engineering and amateur guide on transmitting tubes ever published by RCA. It contains comprehensive data on 69 RCA Air-Cooled Types including the 815, 816, 8000, 8001, 8003, 8005, 9001, 9002, and 9003. Don't be without this book another day.

# HAM TIPS from RCA

6



## VFO Gives 10 to 25 Watts Output

(Continued from page 5, column 4)

$$\frac{1}{C_{series}} = \frac{1}{C_{net}} - \frac{1}{C_{tuning}}$$

$$\frac{1}{C_{series}} = \frac{1}{-324} - \frac{1}{450}$$

$$C_{series} = 1340 \mu\mu f$$

This 1010  $\mu\mu f$  capacitance may be made up of several zero-coefficient condensers in parallel with each other and with a small adjustable padder.

The above calculations are, of course, complicated by the presence of stray tube and circuit capacitances. However, by carefully estimating and allowing for stray tube and circuit capacitances, it is possible to come out fairly closely. Use of partially adjustable padders will make up for reasonable errors. It should be mentioned in passing that, in practice, more error results from inaccurate coil-size calculations, than from inaccurate stray-capacitance allowances.

### READING LIST

1. A Stabilized Variable-Frequency Oscillator, Brown, July 1940 QST.
2. E.C.O. Exciter with 20 Watts Output, Mix, October 1940 QST.
3. An Answer to the ECO Problem, Perrine, September 1939 QST.
4. An E.C.O., 1940 Model, Southworth, November 1940 QST.
5. Notes on ECO Drift, June 1940 QST, p. 68.
6. VFO for Transmitter, Griffin, November 1938 QST.
7. Refinements in Combination Exciters, Ferril, October 1938 QST.
8. A Five-Band Switching Exciter, Kinn, September 1938 QST.
9. Improving ECO Stability, August 1938 QST, p. 28.
10. Look for Me On-Kc., Tilton and Browning, July 1938 QST.
11. Combined VFO and 100-kc. Standard, Stephens, March 1940 Radio.
12. Standard Frequency Crystal Unit, January 1939, QST.
13. A 50-, 100- and 1000-KC. Oscillator, September 1941, QST, p. 32.
14. Let's Talk E.C.O., Stiles and Blair, August 1941 QST.
15. A Transmitter Frequency Control Unit with Three-Band Output, Shuart, June 1941 QST.
16. An Improved ECO, Metcalf, May 1941 QST.
17. A Gang-Tuned V.F.O., Goodman, March 1941 QST.
18. The "Variarm 150," Rice, January 1941 QST.

TABLE I  
807 PLATE TANK COIL (L<sub>6</sub>)

Output Band Meters	Diameter Inches	Length Inches	No. Turns	End Link Turns
160	1 1/2	1 1/2	45	3
80	1 1/2	1 1/4	32	3
40	1 1/2	1 1/4	18	2
20	1 1/2	2 1/4	13	2
10	1 1/2	2	8	2

- C<sub>1</sub> = 50  $\mu\mu f$  Mica 1000 V.
- C<sub>2</sub> = 50  $\mu\mu f$  0.020" plate spacing Cardwell ZR50AS.
- C<sub>3</sub> = C<sub>4</sub>, C<sub>5</sub>, C<sub>6</sub>, C<sub>7</sub>, C<sub>X</sub> 0.01  $\mu f$  600 V.
- C<sub>10</sub> = 0.01  $\mu f$  2000 V.
- C<sub>11</sub> = 18  $\mu\mu f$  two section single ended condenser Cardwell.
- C<sub>12</sub> = 75  $\mu\mu f$  Special XC-75-18-XD.
- C<sub>13</sub> = 50  $\mu\mu f$  Cardwell JD-50-OS
- C<sub>14</sub> = 0.002  $\mu f$ .
- C<sub>17</sub> = 100  $\mu\mu f$  .020 spacing Cardwell Trim-Air ZO-100-As.
- C<sub>18</sub> = 50  $\mu\mu f$  .050 spacing Cardwell Trim-Air EO-50-FS.

- R<sub>1</sub> = 100-ohms 2W.
- R<sub>2</sub> = 100-ohms 2W.
- R<sub>3</sub> = 20,000 Ohms 2 W.
- R<sub>4</sub> = 10,000 Ohms 2 W.
- R<sub>5</sub> = 20,000 Ohms 100 W.
- R<sub>6</sub> = 40,000 Ohms 200 W.
- R<sub>7</sub> = 25,000 Ohms 50 W.
- RFC<sub>1</sub>, RFC<sub>2</sub> = 8 to 10 turns #16 DDC wound on R<sub>1</sub> and R<sub>2</sub>.
- RFC<sub>3</sub> = R. F. choke National R100.
- RFC<sub>4</sub> = Ohmite 160-meter choke.
- L<sub>1</sub> = L<sub>2</sub>, L<sub>3</sub>, L<sub>4</sub>, L<sub>5</sub> B&W type BTCL turret 160-10 meters.

- L<sub>6</sub> = B&W type 2A band-switch coils.
- L<sub>7</sub> = Special final tank coils.
- SW<sub>1</sub> = BTCL turret switch.
- SW<sub>2</sub> = 2A band switch B&W.
- SW<sub>3</sub> = H&K three section switch.
- T<sub>1</sub> = 10-V, 10-Amp. Filament transformer.
- T<sub>2</sub> = (Not shown) 6.3 V. 1 Amp. 807 filament. (center tap ungrounded.)

NOTE: The small padding condenser shown across the 160-meter turret coil is for elimination of any resonance absorption in this particular coil on 10 and 20 meters. Capacity of this padder is 50  $\mu\mu f$  and a mica-type receiving condenser will be satisfactory.

## W3DGP 807-813 RIG A MASTERPIECE OF DESIGN AND CONSTRUCTION

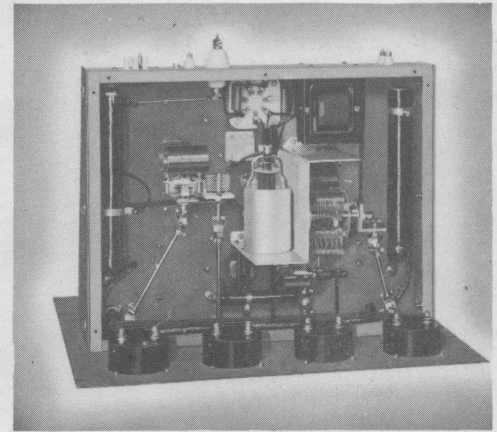
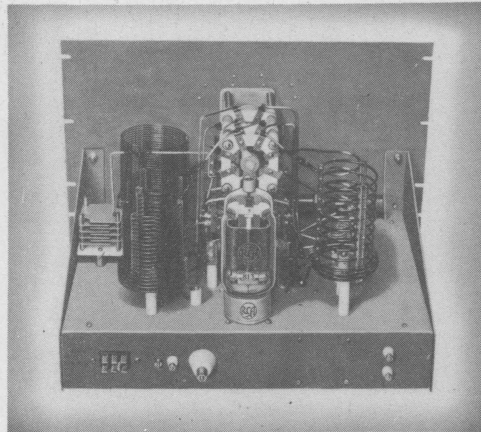

This transmitter deserves special commendation. It was built with careful thought and with a mind to reliability and performance. It consists of an 807 buffer/multiplier stage driving an 813 final. The 807 may be driven by an external crystal oscillator or by a good ECO. Approximately 3 watts of input is all that is necessary for 807 excitation on any frequency. The buffer/multiplier stage is ingeniously located beneath the chassis, the final above it. All circuits are band-switching. Output efficiency of the final is approximately 70% on 10 meters and 75% on 20, 40, 80, and 160 meters.

## SCHEMATIC CIRCUIT DIAGRAM

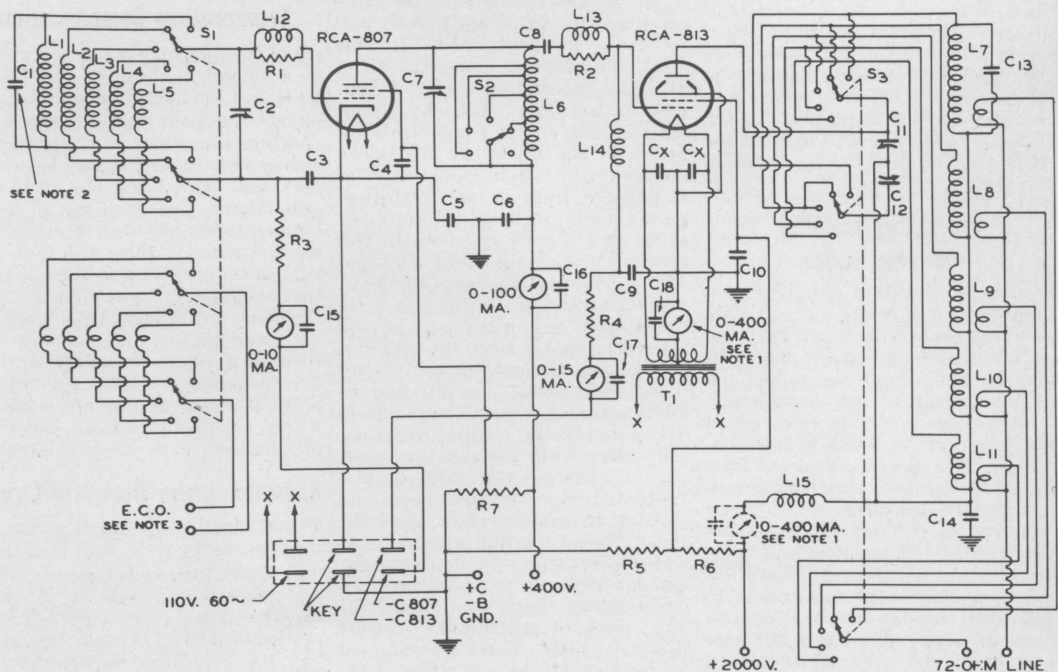

## W3DGP 807/813 BEAM POWER TUBE TRANSMITTER

Output efficiency, 70 to 75% on 5 bands

The license extended to the purchaser of tubes appears in the License Notice accompanying them. Information contained herein is furnished without assuming any obligation.