

HAM TIPS



A PUBLICATION OF THE TUBE DEPARTMENT · RCA · HARRISON, N. J.

Volume 13, No. 4

December, 1953

A Precision "Slick Whistle" for 3.5 to 4 Mc

500-Kc Band Covers Approximately 500 Dial Divisions*

By F. S. Barkalow, † W2BVS

AFTER several contacts with hams who are "rock bound," one wonders why these operators handicap themselves by not employing a VFO. After receiving a few compliments on the operation of this VFO, the author

asked a few of these hams why they didn't build a VFO. Most answers indicated that these hams postponed building a VFO because they assumed that frequency drift and questionable accuracy of calibration characterize all home-

* See caption for Fig. 1.

† RCA Tube Dept., Harrison, N. J.

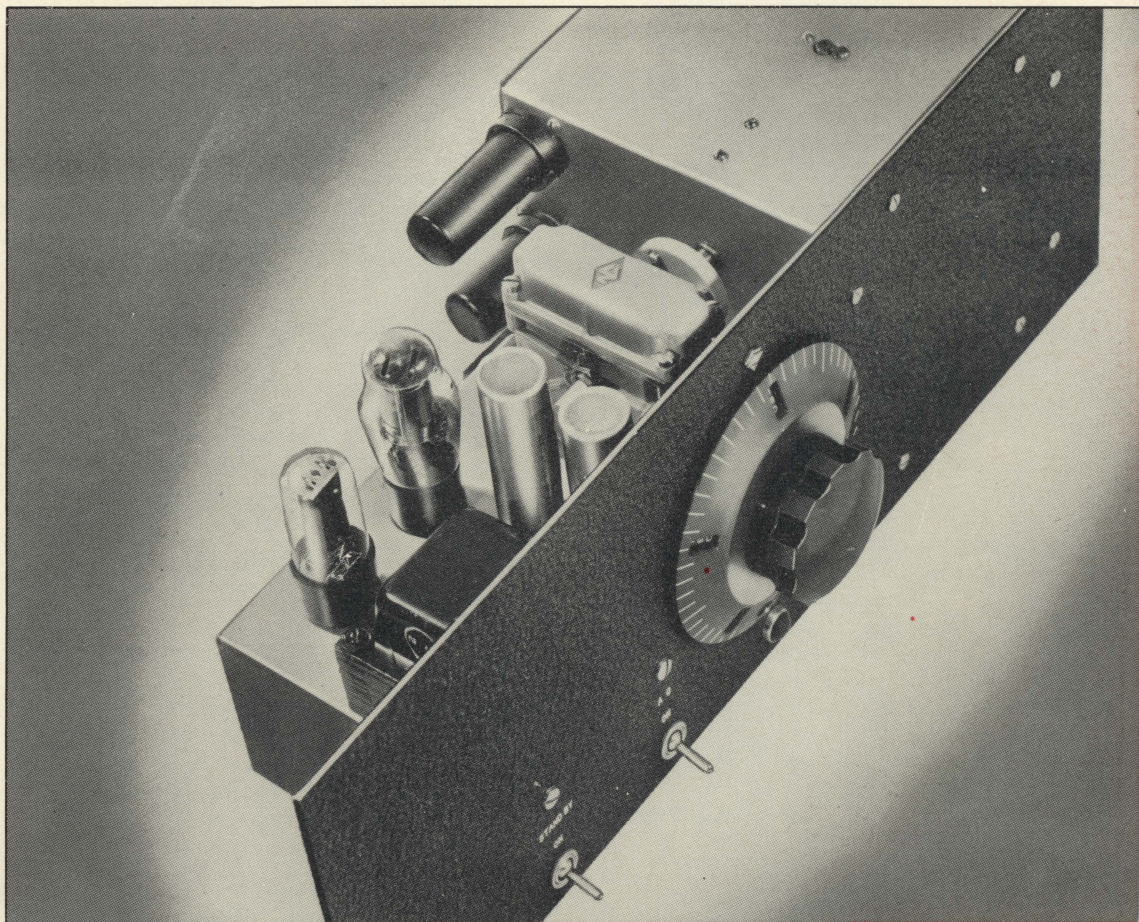

made VFO's.

Stability and Accuracy

These were the watchwords! The VFO described in this article features rugged mechanical design plus voltage regulation to help insure frequency stability. Further assurance against frequency drift is obtained by operating this unit with its plate voltage on continuously during transmission, i.e., as a non-keyed VFO.

The problem of obtaining useful frequency calibration was solved by using a straight-line-frequency tuning capacitor together with a precision dial. Using this scheme and readily-available components, a roughly linear frequency-calibration curve has been obtained (See Fig. 1). Furthermore, the 500-Kc band (3.5-4 Mc) covers 497 of the 500 dial divisions. Thus, the actual frequency of the VFO (in Kc) is roughly equal to the dial reading plus 3,500.

This VFO has a high-impedance output circuit and works nicely into the crystal socket of a pentode oscillator; however, it has sufficient output to drive such tubes as an 807 or 6146 on 80 meters. For operation on 40 or 20 meters, external doubler stages are required.

General Description

The first stage employs a 6J5 in the widely used and reliable Clapp oscillator circuit. For additional output and isolation of the oscilla-

tor, a 6AG7 buffer is used. There is no tracking problem because the buffer employs an untuned tank circuit having low Q. The VFO has a conventional self-contained power supply utilizing a 5Y3-GT rectifier and an OD3 voltage regulator.

Because of the shielding provided by their metal shells, the oscillator and buffer tubes are mounted outside the oscillator box where their heat dissipation cannot affect the frequency stability. The use of silver-mica fixed capacitors, rugged, bus-bar wiring in the frequency-determining circuit, and regulated voltage on the oscillator plate and buffer screen, further contributes to the frequency stability of this unit.

Because the 500 divisions of the dial correspond to 180° of rotation, only a 180° portion of the 270° of rotation of the straight-line-frequency tuning capacitor C_2 is used. Originally, this VFO employed a tuning capacitor of the straight-line capacitance type. Substitution of the only available (locally) straight-line-frequency capacitor did pose a problem, however. The dial-shaft rotation (clockwise for an increase in number) did not correspond with the rotation of the tuning capacitor (counterclockwise for a decrease in capacitance, or increase in frequency). This problem was solved by removing the rotor and stator plates from their respective mounts and turning them over 180° and replacing them exactly in the order in which they were re-

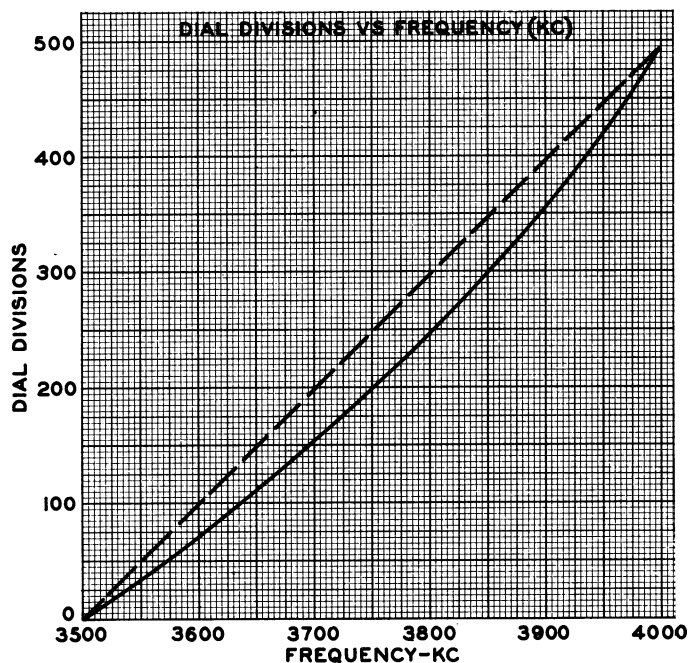

Fig. 1. Calibration curve showing frequency vs dial reading. If the calibration curve coincided with the straight line shown, the dial reading plus 3,500 would equal the VFO frequency in kilocycles. However, the dial readings have more utility than those on an arbitrary scale in that they roughly indicate the number of kilocycles above the low-frequency end of the band.

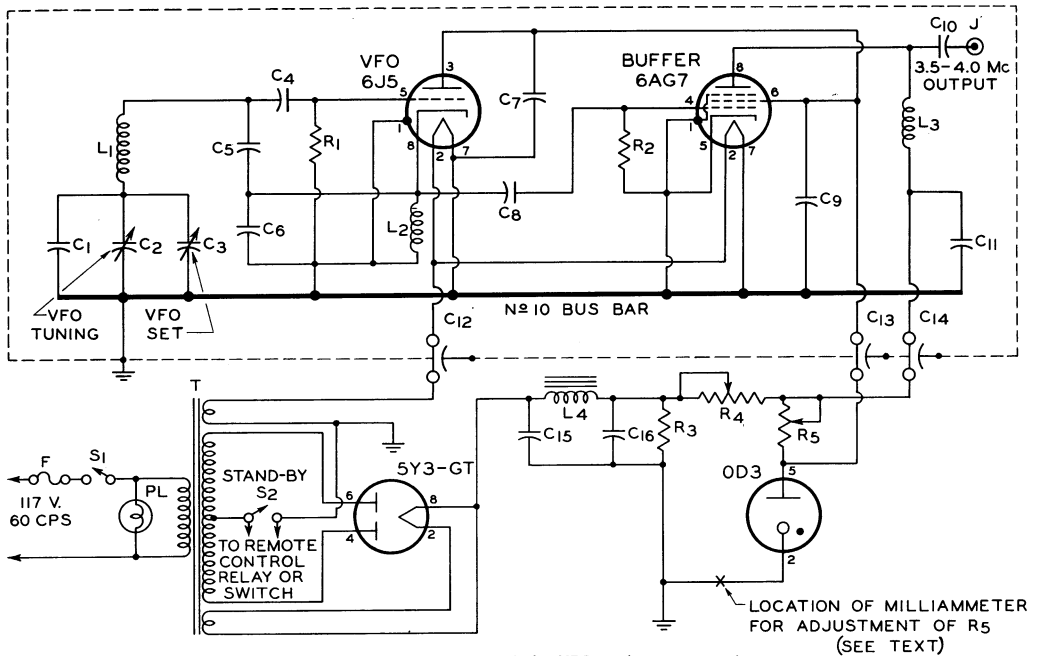

Fig. 2. Schematic diagram of the VFO and power supply.

- C₁, C₄, C₈, C₁₀ 100 μ f, silver mica (El-Menco CM-15-E-101-J).
- C₂ 75 μ f, variable (National SE75).
- C₃ 50 μ f, variable (Bud LC2079).
- C₅, C₆ .001 μ f, silver mica (El-Menco CM-30-102).
- C₇, C₉, C₁₁ .01 μ f, disc ceramic (El-Menco).
- C₁₂, C₁₃, C₁₄ .0015 μ f, feed through (Erie 362-152).
- J Connector (Cinch-Jones S-101).
- L₁ 23 turns, No. 16 enameled, spaced to occupy 2 1/2 in., 2 in. diam (B & W 3907 coil stock).
- L₂ RFC, 2.5 mh (National R-100).
- L₃ RFC, 5.0 mh (National R-100).
- PL Drake No. 10.
- R₁ 100K, 1 watt.
- R₂ 50K, 1 watt.

Power Supply

- C₁₅, C₁₆ 16 μ f, 450 wv (Cornell-Dubilier KR516A).
- F 3AG, 1 amp (for Littlefuse 342001 holder).
- L₄ 12 h, 80 ma (Thordarson 20C53).
- R₃ 30K, 10 watts.

- R₄ 2K, 25 watts (Ohmite Dividohm 0377).
- R₅ 5K, 25 watts (Ohmite Dividohm 0382).
- S₁, S₂ SPST, toggle, 125 v, 3.5 amp.
- T 300-0-300 v, 70 ma; 5 v, 2 amp; 6.3 v, 3 amp (Thordarson T22R02).

Miscellaneous

- Chassis 3" x 5" x 7," aluminum (ICA 29047).
- Dial National PW-O.
- Flexible coupling National TX9.
- Panel 7" x 19," 1/8" aluminum (ICA 8603RS).
- VFO shield box 6" x 6" x 6," aluminum (ICA 29843).

NOTE

The appearance of a manufacturer's name following the description of a particular component should not be interpreted as a recommendation to use that particular brand. Brand names are included only to fully identify the components which are visible in the photographs. In almost all cases, equivalent components made by other manufacturers may be substituted for those shown in this parts list.

moved. Before this modification, the pigtail wire which passed through the rotor was carefully unsoldered. If the original plans had included the use of this capacitor, the whole layout would have been reversed, i.e., the oscillator box would be located behind the left-hand side of the panel and the power supply on the right-hand side.

Constructional Details

There are several reasons for the unusual layout; however, the two-unit construction was decided upon mainly because it permits easy wiring within the VFO box and also because the power-supply chassis provides a convenient spot for mounting the dial gear box.

The oscillator box is a standard 6 by 6 by 6-inch item, and the power-supply chassis measures 5 by 7 by 3 inches; these are fastened

to a 7 by 19-inch panel. For additional strength, the oscillator box is also fastened to the power-supply chassis by means of the bakelite block shown in Fig. 4. The power supply is fastened to the panel with three machine screws. One of these screws (not visible in the photograph) is located under the dial; this screw is a flat-head type. Both units are mounted on the panel after wiring. Care must be exercised in mounting the oscillator box and power-supply chassis in order to obtain perfect alignment of the gear-drive and tuning-capacitor shafts.

Careful examination of the photos will show that paint on the back of the front panel has been removed from those areas where each unit makes contact with the panel. This was done to insure a good ground connection between the units and the panel.

The special attention and care which were exercised during the construction of the oscillator box have "paid off"—the VFO produces a vibration-free note. If the oscillator components are mounted and wired while the oscillator is detached from the front panel, a much better job will result.

Vibration of leads in the frequency-determining circuit can raise havoc with the note; therefore, wherever possible, ceramic standoffs and lug terminal strips are used to strengthen the lead terminations. For the same reason, bus bar has been used for a common ground.

Heater and B + leads from the VFO to the power supply pass through feed-through

capacitors. These capacitors are used to keep rf from feeding back to the power supply and also to prevent these connecting leads from radiating harmonics.

Line-voltage and stand-by switch connections are made through a connector on the rear apron of the power supply as shown in Fig. 4. This type of connector was used to conform with other connectors on the author's rack-mounted transmitter.

Wiring Procedure

A length of No. 10 bus bar serves as a common ground; it is connected to ground *only* through the rotor shaft of the tuning capacitor. All oscillator-box ground connec-

Fig. 3. Rear view of the oscillator box with the cover removed. The ground bus is bent and routed so that it functions as a common, convenient, vibrationless ground.

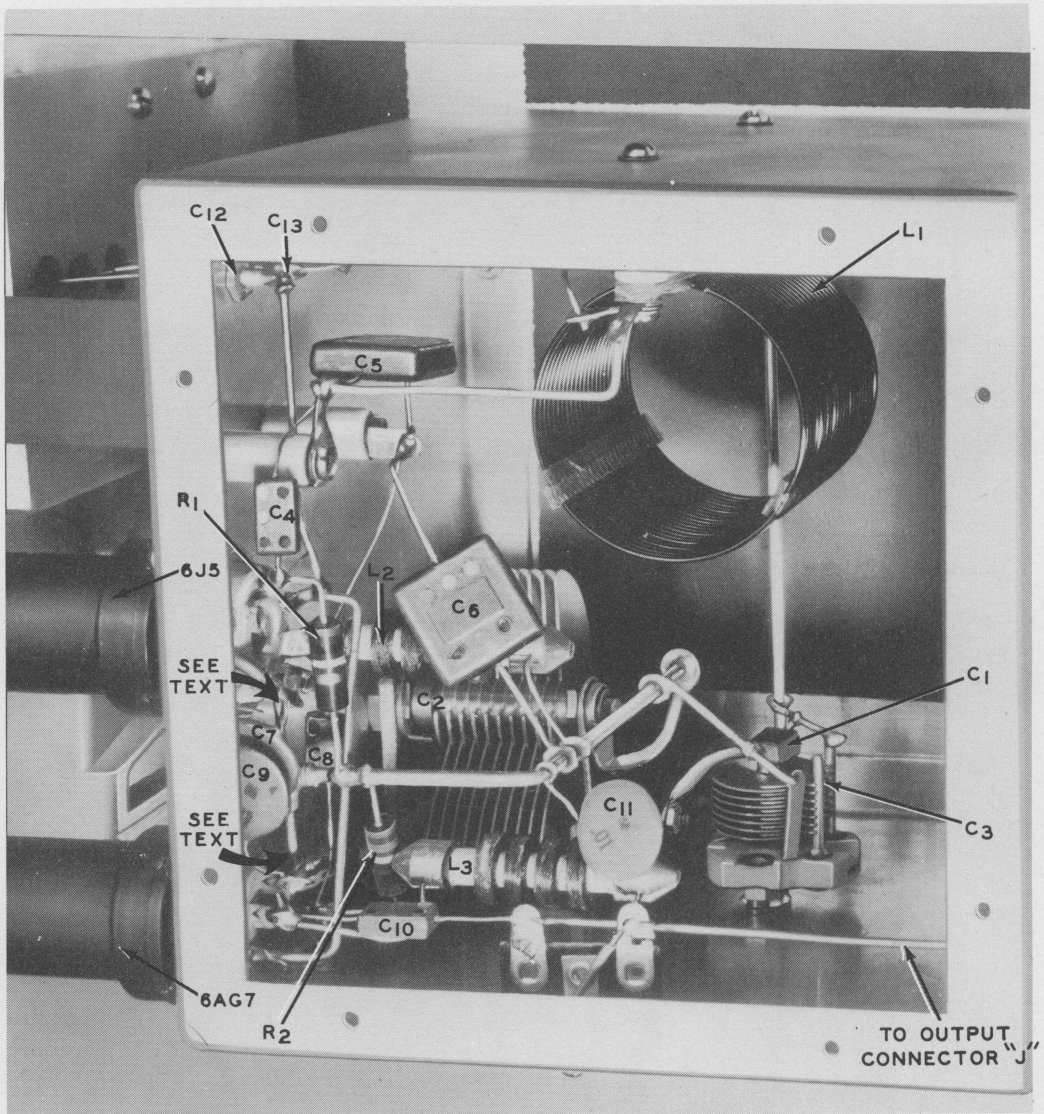

tions are made to this bus. The other end of this bus is supported by the heater lug of each tube socket which is to be grounded (See arrows in *Fig. 3*). This routing of the ground bus is also clearly shown in *Fig. 3*.

The use of such a ground system eliminates ground loops which may be set up if the ground connections are made in several places on the chassis. The effect of one type of ground loop was demonstrated when an aluminum block was used (in place of the bakelite block previously mentioned) for mechanical support between oscillator box and power-supply chassis. The loop created by the addition of the aluminum block changed the calibration by approximately 20 Kc.

Connections to coil L_1 , the band-set capacitor C_3 , and to capacitors C_4 - C_6 should be made as direct as possible and with bus bar. All other components should also be wired with short connections.

The forming and bending of the bus bar should be done before it is soldered. This procedure eliminates undue lever-action strain on lugs and terminals which would occur if bending was done after soldering one end of the bus.

Exercise reasonable care while mounting and soldering feed-through capacitors C_{12} - C_{14} . Too much pressure during the nut-tightening operation or too much heat when wires are soldered to either end of these capacitors will cause damage.

Adjustment and Calibration

Insert a milliammeter at point "X" in the circuit (See *Fig. 2*.) and connect a voltmeter from the junction of R_4 and R_5 to ground.

Turn on the standby switch a half minute or so after the rectifier filaments have reached their operating temperature.

Alternately adjust resistors R_4 and R_5 until the voltmeter indicates approximately 280 volts and the milliammeter indicates approximately 10 ma. Use an insulated screwdriver to loosen and tighten the sliders on R_4 and R_5 . (Although it takes a little more time, for safety reasons it is advisable to turn the power switch off each time an adjustment is made.) After these adjustments are made, remove the temporary meter connections. With these settings of resistors R_4 and R_5 , the voltages on the oscillator and buffer tubes should be as follows:

6AG7 Plate—	280 volts (at 20 ma)	
6AG7 Screen—	150 volts	} (at 15 ma)
6J5 Plate—	150 volts	

A signal source, a fairly good wavemeter, or a heterodyne frequency meter will be required to calibrate the VFO; the writer used a heterodyne frequency meter. It is preferable to do the calibrating at normal room temperature; also, it is desirable to allow the oscillator to warm up for at least 15 minutes with the stand-by switch turned on. From a cold start, the oscillator drifts about + 1 Kc; however, at the end of 15 minutes the drift is negligible.

Loosen the set screws on the dial side of the flexible coupling and, with the dial set at the first division mark, rotate C_2 to a position about one third out from the maximum-capacitance position; tighten the set screw on the coupling. With the rotor of capacitor C_3 set practically all the way out, the low-fre-

(Continued on page 7)

Fig. 4. Note the coiled flexible lead connecting the slider to one end of the bleeder thereby shorting out the unused resistance. Because the connection to the slider is terminated on the fixed end terminal, this arrangement prevents damage to the resistance wire by keeping the strain off the slider.

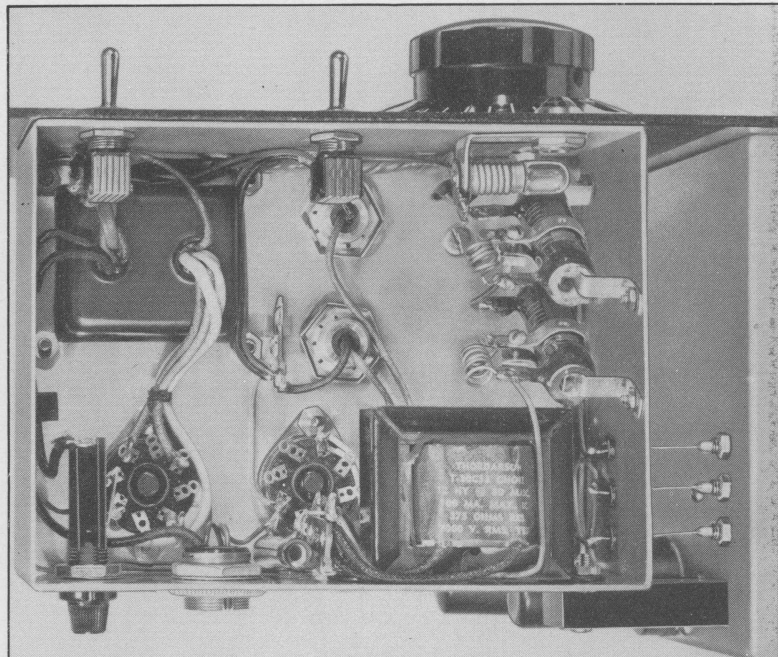

How to Determine Driver-Transformer Requirements for the Modulator

By
C. A. West, † W2IYG

After selecting the tubes and power requirements for the modulator, and the class of service for the modulator tubes and driver, the amateur is faced with the problem of selecting a suitable driver transformer for the modulator. A simple, straightforward procedure for calculating the turns ratio of the driver transformer for class AB₂ or class B service, using a few simple equations and published tube data, follows:

1. Refer to your tube manual or tube bulletin and select from the "Typical Operation" data for the driver tube (or tubes) the load resistance, R_L , for the desired value of plate voltage. For push-pull operation, the effective load resistance is given as the plate-to-plate value.

2. Determine the effective grid resistance, R_g , of a single modulator tube from the following approximate relation:

$$R_g = \frac{E_g^2}{8P}$$

where: E_g is the peak of grid-to-grid voltage (given in the published tube data).
 P is the max.-signal driving power (given in the published tube data).

3. Substitute the values of R_L and R_g in the following formula:

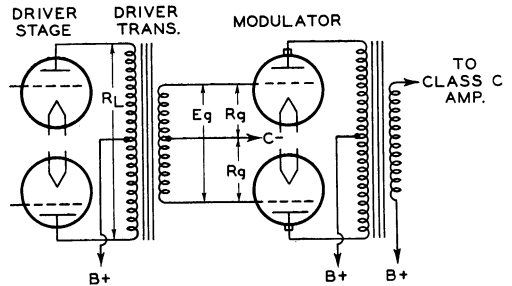

Fig. 1. For a push-pull driver stage, R_L represents the plate-to-plate load resistance. Note that R_g applies to a single modulator tube and that E_g is the grid-to-grid voltage.

$$\text{turns ratio} = \sqrt{R_L / R_g}$$

If R_L is greater than R_g , the ratio is step-down; if R_L is less than R_g , the ratio is step-up. The proper impedance ratio of the entire primary winding to one-half of the secondary winding should be the same as the ratio of the load resistance, R_L , to the effective grid resistance, R_g , of a single modulator tube.

The above procedure is illustrated below:

Example. A pair of 811-A tubes have been selected to operate as class-B modulators with a plate-supply voltage of 1250 volts. The required maximum-signal driving power, P , and the peak of grid-to-grid voltage, E_g , are given in the published data (under ICAS conditions*) as 6.0 watts and 175 volts, respectively. In

† Tube Dept., Radio Corp. of America, Harrison, N. J.

* Intermittent Commercial and Amateur Service.

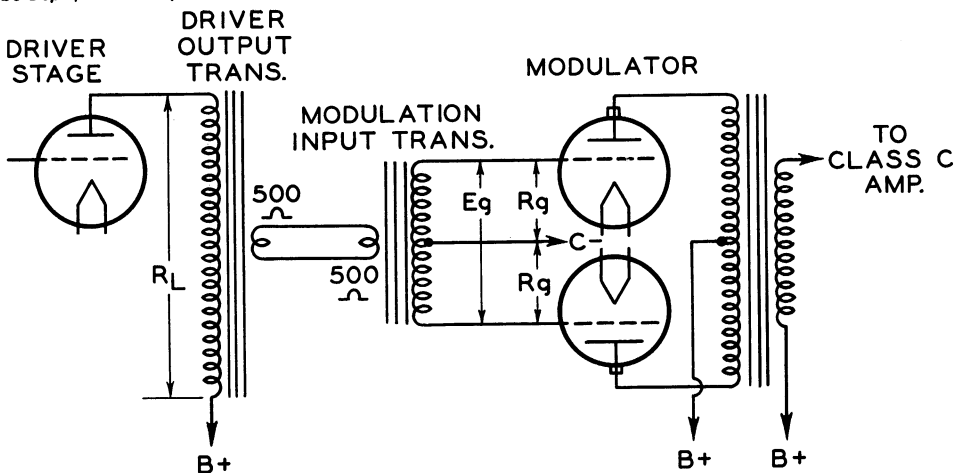

Fig. 2. If a 500-ohm line is employed between the driver stage and the modulator, 500 ohms must be substituted for R_g in the formula for the turns ratio of the driver output transformer. Similarly, 500 ohms should be substituted for R_L in the formula for the turns ratio of the modulator input transformer.

order to obtain ample driving power and to allow for circuit losses, a pair of push-pull 2A3's (operating class AB₁, with fixed bias and 300 volts on the plate) was selected to drive the modulator. The power output available from the 2A3's is approximately 15 watts.

1. The plate-to-plate effective load resistance for the push-pull 2A3's is given in the tube data as 3000 ohms.

2. The effective grid resistance of a single 811-A is

$$R_g = \frac{E_g^2}{8P} = \frac{(175)^2}{8(6)} = 638 \text{ ohms.}$$

3. The turns ratio of the driver transformer (full primary/one-half of the secondary) is

$$\sqrt{\frac{R_L}{R_g}} = \sqrt{\frac{3000}{638}} = \frac{2.16}{1} \text{ (step-down).}$$

If a 500-ohm line is to be used between the driver stage and the modulator, the turns

ratio of the driver output transformer and the modulator input transformer may be determined as follows:

1. The turns ratio of the driver output transformer (primary/secondary) is

$$\sqrt{\frac{R_L}{500}} = \sqrt{\frac{3,000}{500}} = \frac{2.45}{1} \text{ (step-down).}$$

2. The turns ratio of the modulator input transformer (full primary/one-half of the secondary) is

$$\sqrt{\frac{500}{R_g}} = \sqrt{\frac{500}{638}} = \frac{1}{1.13} \text{ (step-up).}$$

In addition to having the proper turns ratio, the transformer selected should be capable of handling the developed power. The use of a vari- or multi-match type transformer provides a wide range of impedance ratios as well as versatility for possible future modifications.

A PRECISION "SLICK WHISTLE" FOR 3.5 TO 4 Mc

(Continued from page 5)

quency end of the VFO tuning range (3,500 Kc) should fall near the first division mark on the dial. Several trial-and-error runs may be necessary to select the proper 180° portion of the tuning capacitor and the proper setting of C₃ to make the full 500 Kc of the 80-meter band cover the 500 dial divisions. If your station has more than one operator, it is a good idea to seal the final setting of C₃ with sealing wax immediately after the VFO is calibrated!

RF output at the output connector on the oscillator box was measured and found to be 45 volts rms with only a five-volt drop at the other end of the band. Connection to the transmitter should be made with unshielded wire of not more than two feet in length.

The use of coaxial cable here is not recommended because its capacitance would shunt the high-impedance output of the buffer.*

Performance

The original calibration of this VFO was checked recently and found to be substantially as accurate as it was the day the curve was plotted. Time and again, schedules were kept on a pre-arranged frequency by returning to the same number on the VFO dial.

* This VFO was installed in the transmitter relay rack. If the VFO is to be located on the operating table several feet from the transmitter, coax may be used if a cathode follower is inserted between the 6AG7 buffer and the coax. (See the first paragraph on pg. 3 of the June-July, 1953 issue of HAM TIPS.

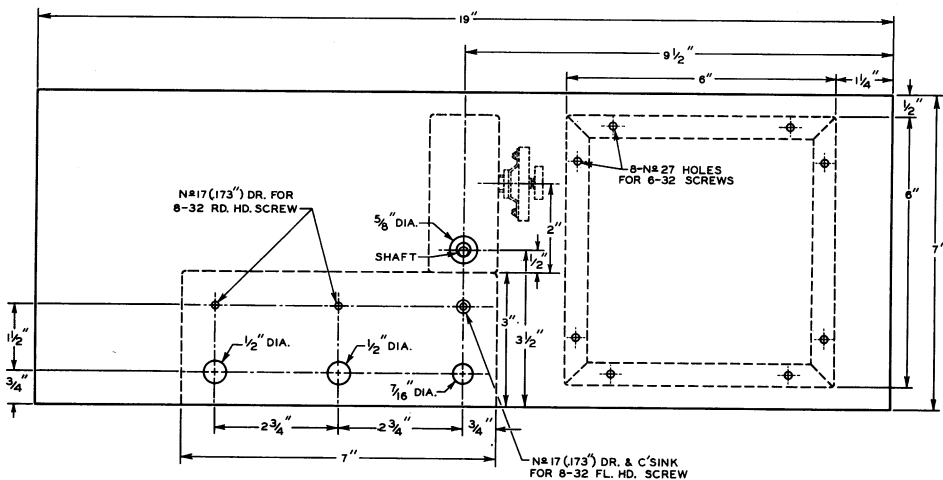

Fig. 5. Panel-layout drawing showing the location of the power-supply chassis, VFO box, and the dial gear box.

TMK. ©



Merry Christmas

and good hunting in

1954

*from the Home of the
RCA Tube Department*

Devices and arrangements shown or described herein may use patents of RCA or others. Information contained herein is furnished without responsibility by RCA for its use and without prejudice to RCA's patent rights.



TMK®

From your local
RCA distributor,
headquarters for
RCA receiving
and power tubes.

RCA HAM TIPS
is published by the
RCA Tube Dept.,
Harrison, N. J.
It is available free
of charge from
RCA Distributors

Joseph Pastor, Jr., W2KCN
Editor

Copyright 1953
Radio Corporation of America

WHEN MAILING
PLACE POSTAGE HERE



FORM 3547 REQUESTED