

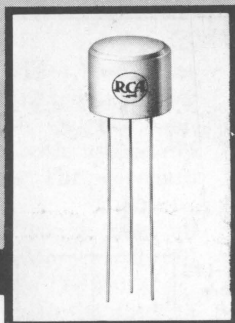

HAM TIPS



A PUBLICATION OF RCA ELECTRONIC COMPONENTS AND DEVICES

VOL. 26, NO. 1

© 1966, RADIO CORPORATION OF AMERICA

WINTER, 1965-66

All-Transistor Two-Meter Converter

By R. M. Mendelson, W2OKO*
RCA Electronic Components and Devices

Until recently, the benefits of an all-transistor, two-meter converter have been outweighed by the unavailability of suitable VHF transistors at a reasonable price.

Today, however, the radio amateur has at his disposal three new RCA transistors offering wide advantages in both cost and electri-

cal characteristics over their tube counterparts. VHF types 40235, 40236, and 40237, for example, enable the amateur to easily obtain noise figures of less than 3 dB at 144 Mc/s. Their small size, instant startup, and excellent reliability are additional features which help meet the requirements of a high-quality converter. Furthermore, the 12.6-volt, 10-milliampere power requirement is ideally suited to mobile operation. In the home station, power is quickly derived through any one of the several methods later described in this article.

In the Figure-2 schematic, the RCA-40235 VHF transistor is shown in the rôle of a neutralized low-noise RF amplifier. An RCA-40237 — used as an overtone crystal oscillator-multiplier — provides an output frequency of 118 Mc/s in one stage. The output from this stage, which is the transistor equivalent of the nuvistor one-stage oscillator described by the author in earlier articles,¹ is mixed with the output of the RF-amplifier stage in an RCA-40236 mixer stage.

The low internal feedback capacitance inherent in these VHF transistors eliminates the need for critical neutralization. The use of a fixed neutralization capacitor allows for final alignment without special test equipment.

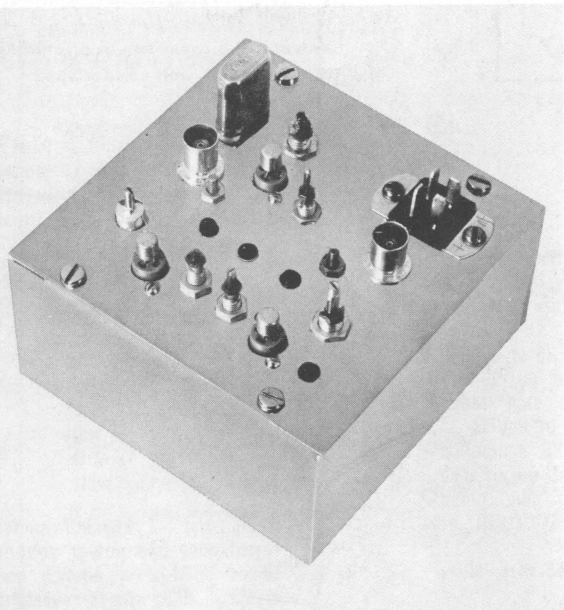
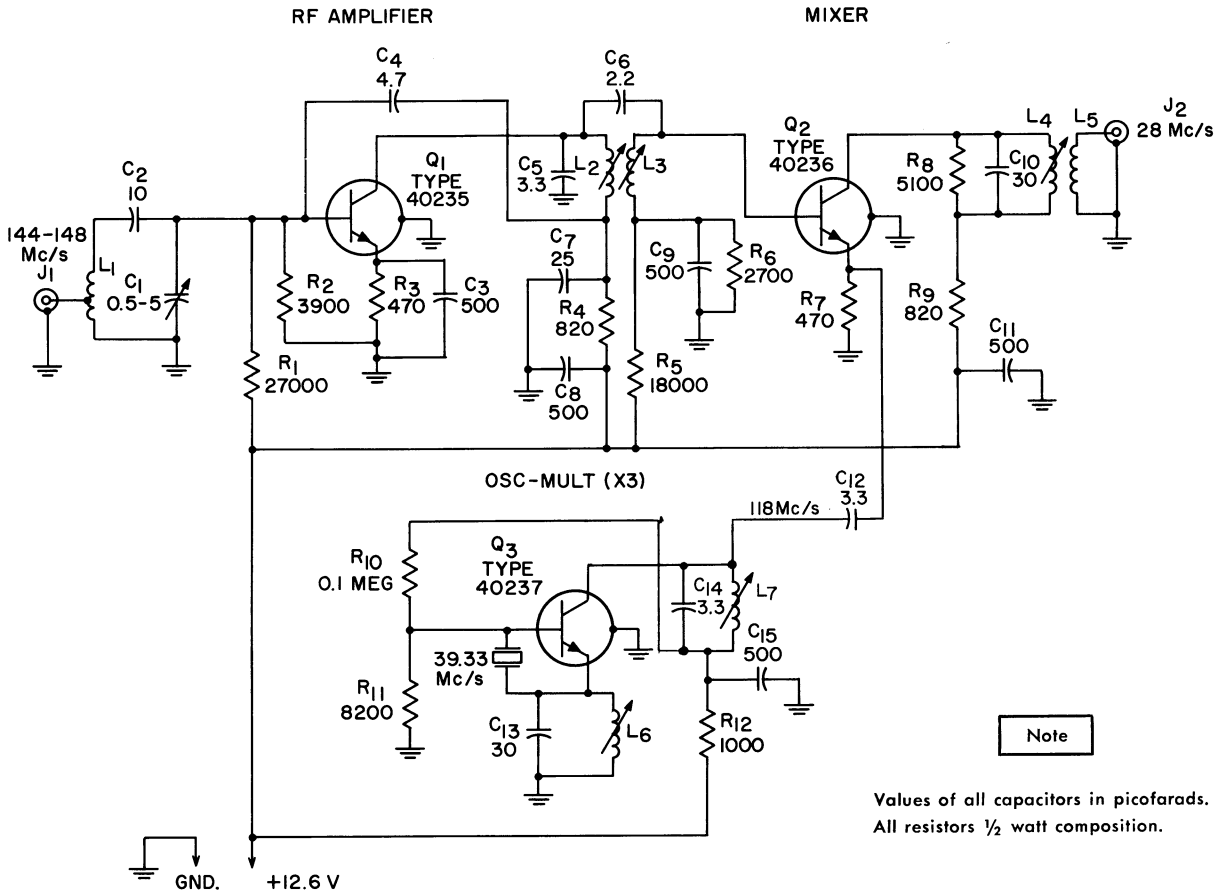

Figure 1: Top view of W2OKO's solid-state two-meter converter showing layout of transistors, crystal, and adjustable coils. Unit measures 4-by-4-by-2 inches.

*Commercial Receiving Tube and Semiconductor Division, Somerville, New Jersey

¹"Nuvistor Two-Meter Converter," RCA Ham Tips Volume 21, No. 2, May, 1961.

"Transistors and Nuvistors in a Two-Meter Transceiver," RCA Ham Tips Volume 25, Numbers 2 and 3, Spring and Summer, 1965.



Note

Values of all capacitors in picofarads.
All resistors 1/2 watt composition.

C₁—0.5-5 pF tubular trimmer (Erie 532-3R or equiv.)

C₂—10 pF ceramic tubular (Centralab TCZ-10 or equiv.)

C₃, C₉, C₁₁—500 pF silver button (Erie 662-003-501K or equiv.)

C₄—4.7 pF ceramic tubular (Centralab TCZ-4R7 or equiv.)

C₅, C₁₂, C₁₄—3.3 pF ceramic tubular (Centralab TCZ-3R3 or equiv.)

C₆—2.2 pF ceramic tubular (Centralab TCZ-2R2 or equiv.)

C₇—25 pF silver button (Erie 662-003-250 or equiv.)

C₈, C₁₅—500 pF ceramic disc (Centralab DD-501 or equiv.)

C₁₀, C₁₃—30 pF ceramic tubular (Centralab TCZ-30 or equiv.)

J₁, J₂—BNC-type coaxial jack

L₁—5 turns, No. 16 bare wire, 1/4-inch diameter (spaced wire diameter), tap one turn up from bottom

L₂, L₃—4 turns, No. 26 enamelled wire, close wound on 1/4-inch diameter ceramic slug tuned form (Miller 4500 or equiv.)

L₄—11 turns, No. 26 enamelled wire, close wound on 3/8-inch diameter phenolic slug tuned form (Miller 21A00ORBI or equiv.)

L₅—3 turns, insulated wire, close wound link

L₆—5 turns, No. 26 enamelled wire, close wound on 3/8-inch diameter phenolic slug tuned form (Miller 21A00ORBI or equiv.)

L₇—7 turns, No. 26 enamelled wire, close wound on 1/4-inch diameter ceramic slug tuned form (Miller 4500 or equiv.)

R₁—27,000 ohms, 1/2 watt

R₂—3,900 ohms, 1/2 watt

R₃, R₇—470 ohms, 1/2 watt

R₄, R₉—820 ohms, 1/2 watt

R₅—18,000 ohms, 1/2 watt

R₆—2,700 ohms, 1/2 watt

R₈—5,100 ohms, 1/2 watt

R₁₀—0.1 megohm, 1/2 watt

R₁₁—8,200 ohms, 1/2 watt

R₁₂—1,000 ohms, 1/2 watt

Miscellaneous—2 standoff solder terminals; one power socket (Jones P304AB or equiv.); one crystal, 39.33 Mc/s overtone (International Crystal Company Type FA5 or equiv.); 3 transistor sockets; one crystal socket (National CS-7 or equiv.); one brass plate 4-by-4-by-1/2 inches.

Figure 2: Schematic diagram and parts list of W2OKO's all-transistor two-meter converter.

Construction

A full-scale template (see Figure 3) is included to simplify construction of this converter. If this layout is duplicated, the possibility of trouble is minimized and alignment made less cumbersome.

Good ground conductivity and solderability can be assured by use of a brass or copper plate for the chassis. For ease of tuning, all coils are slug-tuned. Ceramic forms are used for higher frequencies; phenolic forms for lower frequencies.

The oscillator frequency was chosen to provide a converter output of 26 to 30 Mc/s. For operation at a lower IF frequency — such as 14-18 Mc/s — the operator need merely increase the crystal frequency from 39.33 to 43.33 Mc/s, and increase the number of turns in the output coil, L₄, to twenty-two. No changes are necessary in the two oscillator coils, L₆ and L₇.

Alignment

Alignment of this all-transistor, two-meter converter is simple, and doesn't require either a sweep generator or oscilloscope. The complete tuneup can be made with a grid-dip meter and the receiver S-meter. The procedure is as follows:

Using the grid-dip meter, "rough tune" all the coils (L₁, L₂, L₃ to 146 Mc/s; L₄ to 28 Mc/s; L₆ to 40 Mc/s; and L₇ to 118 Mc/s).

Next, connect the converter to the antenna and the receiver and apply power. Optimum supply voltage is 12.6 volts, but a variation of plus or minus one volt will not cause any degradation. A check for correct wiring may be made by comparing voltages with those given in the following table. All voltages are with respect to ground and may vary as much as 20%. Measurements are made with a 20,000-ohms-per-volt meter. Input voltage equals 12.6 volts.

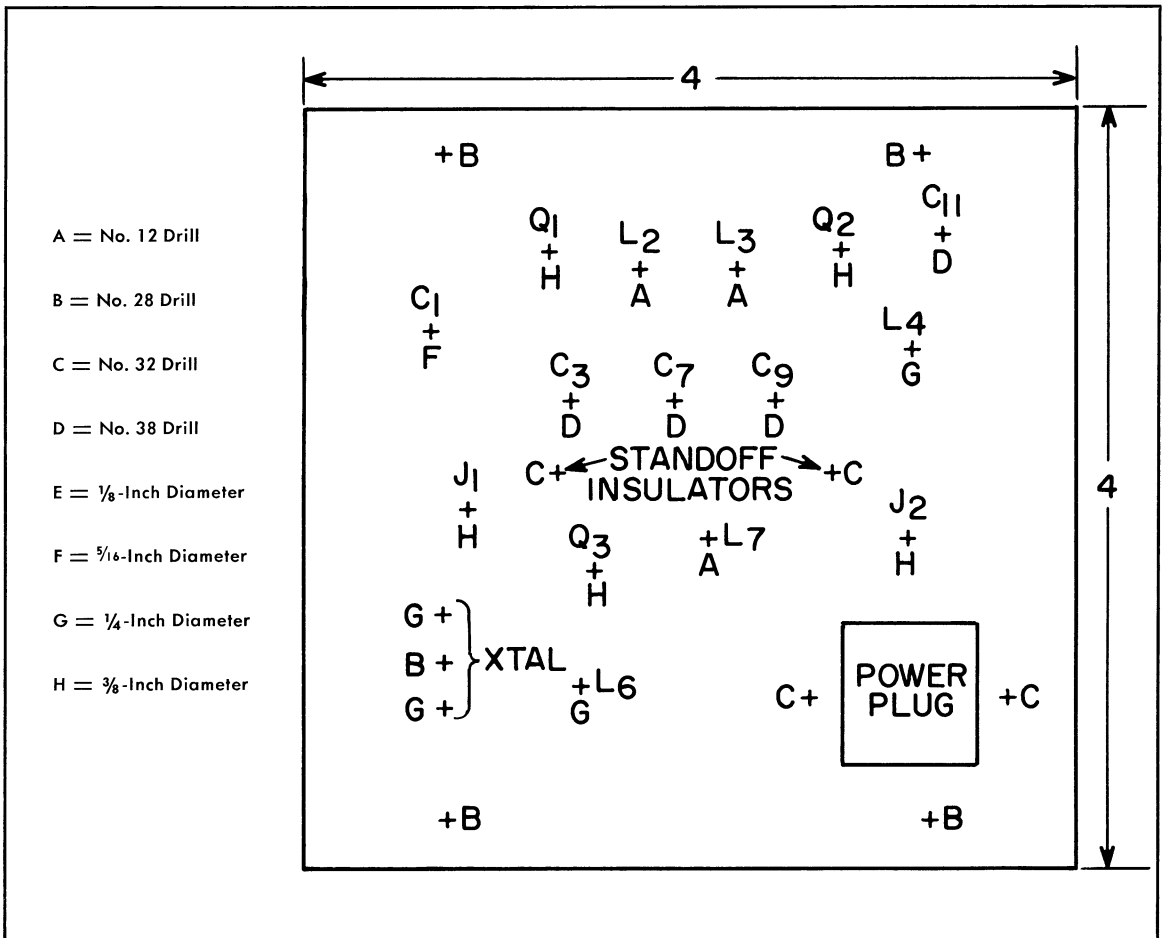

Figure 3: Bottom view of chassis plate as actual-size template. Note that "A" through "H" are drill sizes.

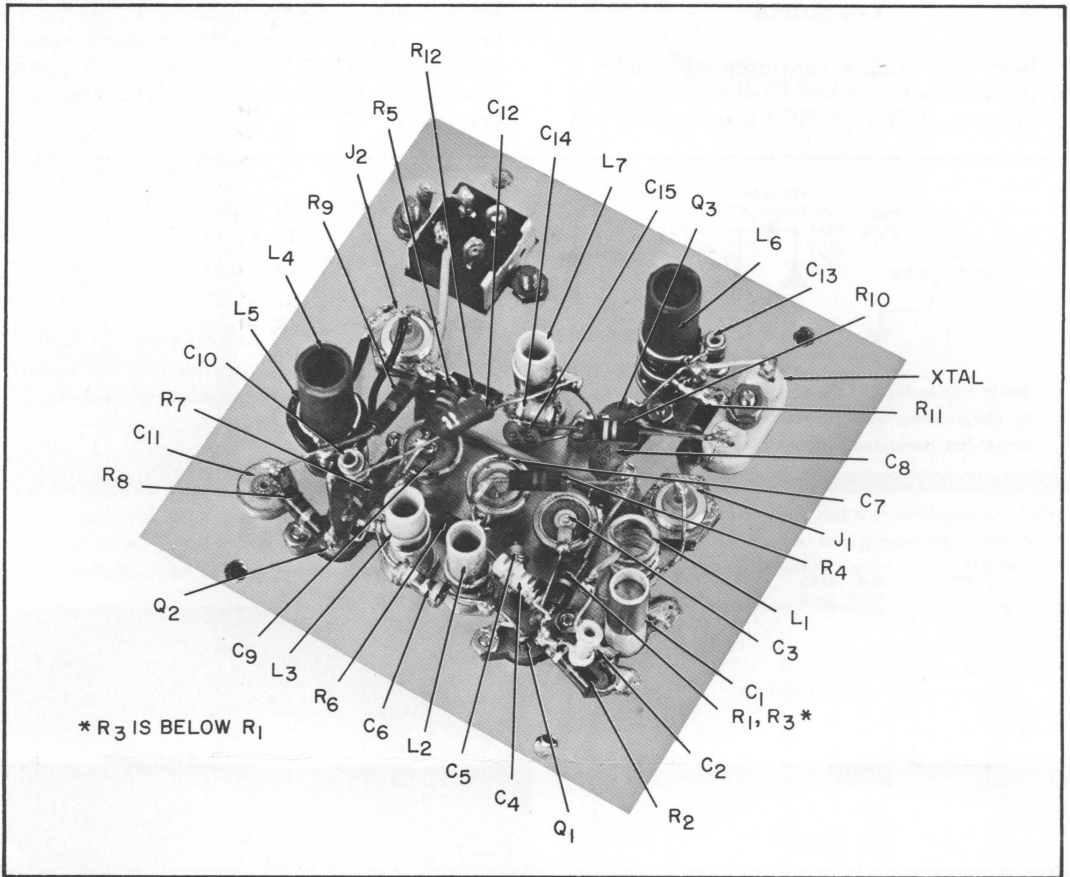

Figure 4: Bottom view of W2OKO's converter showing wiring of various components. Note that this photo layout can be related to the template diagram shown at left in Figure 3.

TABLE

VOLTAGE	TRANSISTOR TYPES		
	(Q1) 40235	(Q2) 40236	(Q3) 40237
Collector to Ground	11.3 V	11.0 V	5.0 V
Base to Ground	1.3 V	1.4 V	0.6 V
Emitter to Ground	0.65 V	0.8 V	0 V

If the converter is operating properly, two-meter signals should be heard. If these signals are not received, the oscillator should be checked. A drop in background noise when the crystal is removed signifies proper oscillator operation. A slight readjustment of L₆ may be necessary to start oscillation. Tune L₇ for maximum output as read on the receiver S-meter.

Tune in a signal at 145 Mc/s and adjust L₂ for a maximum S-meter reading. Repeat at

147 Mc/s but now tune L₃ for a maximum S-meter reading. With a signal at 146 Mc/s, adjust L₁ for maximum response. This tuning will be broad.

Adjust the tuning of L₄ to give a fairly uniform response across the whole band.

Power Supply

Power for mobile operation is easily obtained directly from the 12.6-volt grounded negative automobile supply.

In the home receiver, there are several sources that may be tapped, four of which are diagrammed in Figure 5. If the receiver employed in conjunction with this converter uses a center-tap grounded heater-voltage supply, the circuit shown in Figure 5(A) cannot be used. A careful check of the receiver schematic will be necessary to decide which power source is best suited. In any case, the total power drain is so low that there is no danger of overloading the receiver.

Conclusion

Brief use of this converter will make it quite obvious to the builder that employment of low-cost, VHF-type, RCA transistors at 144

Mc/s is not only very practical but provides benefits well worth any effort expended in construction. Once properly aligned, the unit should give many years of maintenance-free operation.

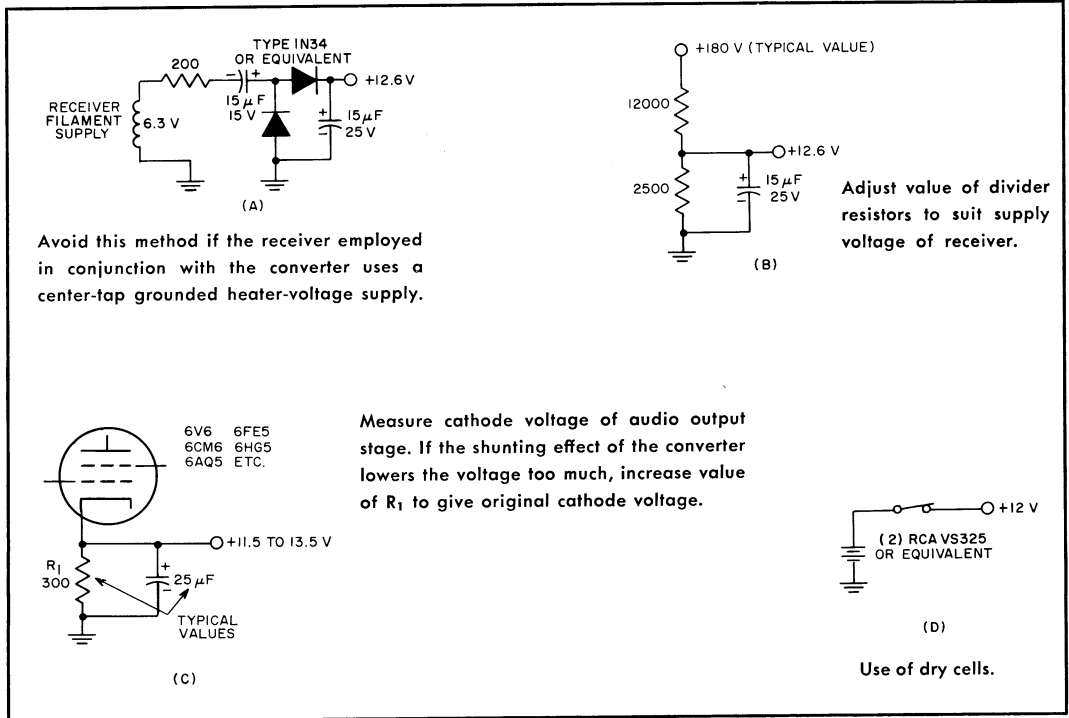

Figure 5: Four alternative methods of obtaining +12.6 volts at 10 milliamperes to operate the W2OKO converter with the home receiver. The author employed Method "C" in the construction of his own particular unit.

RCA Amateur Radio Operator Builds \$250 Ground Station To Record Weather Pictures From TIROS Satellites

Weather satellites cost millions to build and launch, but ham radio operators from Moscow to Tanganyika could obtain good weather pictures from space by adding to their receivers such mundane items as a rolling pin, a rubber band, and an argon electric light bulb.

Wendell Anderson, K2RNF, an engineer with the Radio Corporation of America, already has built such a "do-it-yourself" ground station for \$250 in the basement of his home, 429 Paul Drive, Moorestown, N. J. — and it works.

Mr. Anderson, who built his receiving station just to prove it could be done, used the system in its original version to obtain weather pictures from the NIMBUS sat-

ellite launched back in September, 1964.

Stimulated by his success, the RCA engineer wrote an article about his project which appeared in the November, 1965, issue of "QST" and received that magazine's award for the best article of the month.

Pictures which he obtained on March 2, 1966, from ESSA 2, the twelfth TIROS satellite, resulted in national press and television coverage.

Right now, he's readying his system in anticipation of receiving weather pictures from the new NIMBUS experimental satellite, which is scheduled for an April launch from Vandenberg Air Force Base in California.

Indispensable!

The brand-new
RCA RC-24
receiving tube
manual

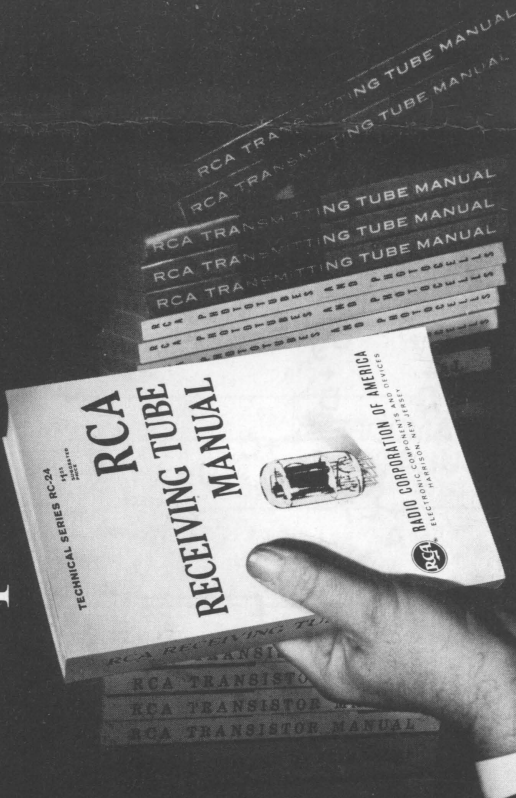

*Complete-authoritative
A must in every
technical library
A must on every work bench
More compact and easier
to read than ever before*

Technical design and applications data on more than 1200 receiving tubes. Check these NEW features and improvements not included in previous editions:

- ✓ Additional data on 100 new tube types
 - ✓ Revised circuits section with new, simple format
 - ✓ Updated picture tube characteristics chart
 - ✓ Revised and updated Applications Guide
 - ✓ New tube index section for ready reference
 - ✓ Data section on active types only. (Discontinued and replacement types appear in a separate section.)
 - ✓ Additional text material on TV in the tube applications section
- Everyone concerned with electronics needs this manual... service technicians, engineers, radio amateurs and hobbyists. Order yours today from your nearest Authorized RCA Distributor.

Only \$1.25*
*Suggested Price

RCA Electronic Components and Devices, Harrison, N.J.



The Most Trusted Name in Electronics

RCA HAM TIPS is published by RCA Electronic Components and Devices, Harrison, N. J. It is available free of charge from participating RCA Industrial Distributors. It is also available on a two-year subscription basis (\$1 for eight issues to cover costs of handling and mailing). Please make check or money order payable to Radio Corporation of America, and remit to "Radio Corporation of America, Section 882, Harrison, N. J. 07029."

DISTRIBUTED BY
GEORGE D. BARBEY CO., INC.
READING LEBANON
LANCASTER POTTSTOWN

BLK. RT.
ADL 3/8¢ PD.

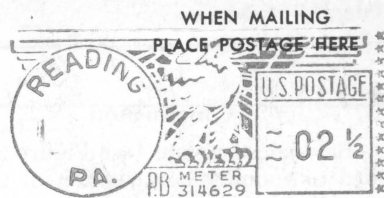

Information furnished by the Radio Corporation of America is believed to be accurate and reliable. However, no responsibility is assumed by RCA for its use; nor for any in-

fringements of patents or other rights of third parties which may result from its use. No license is granted by implication or otherwise under any patent or patent rights of RCA.