

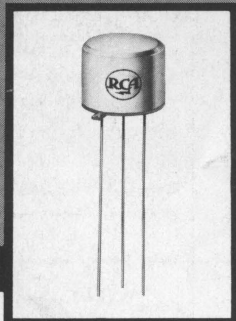

HAM TIPS



A PUBLICATION OF RCA ELECTRONIC COMPONENTS AND DEVICES

VOL. 27, NO. 2

© 1967, RADIO CORPORATION OF AMERICA

AUGUST, 1967

A VFO CALIBRATOR

By George D. Hanchett, W2YM*

RCA Electronic Components and Devices

To many of our readers who are also readers of "QST" Magazine, the following article and the name of its author should have a familiar ring. In the December, 1966, issue of that magazine, George D. Hanchett reported on "The Field-Effect Transistor as a Stable VFO Element" and was honored with the QST Cover Award for having submitted the most outstanding article of the month. In his current "Ham Tips" article, Mr. Hanchett supplements his earlier contribution with a highly useful device whose need was envisioned during the course of his experimentation with variable-frequency oscillators. This device offers a solution to the problem confronted by radio amateurs who own receivers limited to hamband frequencies and have no way of calibrating VFO's which operate outside those frequencies. The "VFO Calibrator" discussed by Mr. Hanchett is designed to calibrate any VFO on any frequency, and serve the radio amateur in other important applications as well.



Convenient, rugged, and compact design of W2YM's VFO calibrator provides users with a long-life instrument that can be employed for numerous hamshack assignments.

During recent experiments with a VFO for operation at frequencies other than those tuned by an amateur-band receiver, it became desirable for the writer to have some type of calibrator to which the VFO could be coupled so that a series of calibration points could be determined and marked on the VFO dial.

The basic idea employed for the VFO calibrator described in this article is not new and will be recognized by many amateurs as the system used in the well-known war-surplus frequency meter, BC-221. (*Editor's Note: The VFO calibrator can also be used to calibrate signal generators, etc.*)

Harmonics of the secondary-standard 100-kHz crystal oscillator are beat with the fundamental, or harmonics, of the VFO to provide audible signals at definite frequencies across the dial. For example, if this unit is used with a 5.0-to-5.5-MHz VFO such as the type widely utilized for SSB operation, the 100-kHz calibration points are the strongest by far. How-

*Solid-State and Receiving Tube Division, Somerville, N. J.

ever, the 50-kHz points are also perceptible and, if proper care is exercised, the 33-, 25-, and 20-kHz points can be detected as well. In practice, the calibrator is permanently connected to the RF line between the VFO and the transmitter, and may be turned on when needed.

Circuit Description

The schematic diagram and Parts List for the calibrator are shown in Figure 1. The 100-kHz oscillator, Q₃, is of the tuned-collector type, with the crystal, Y₁, inserted in the base feedback circuit. The 25-pF padder

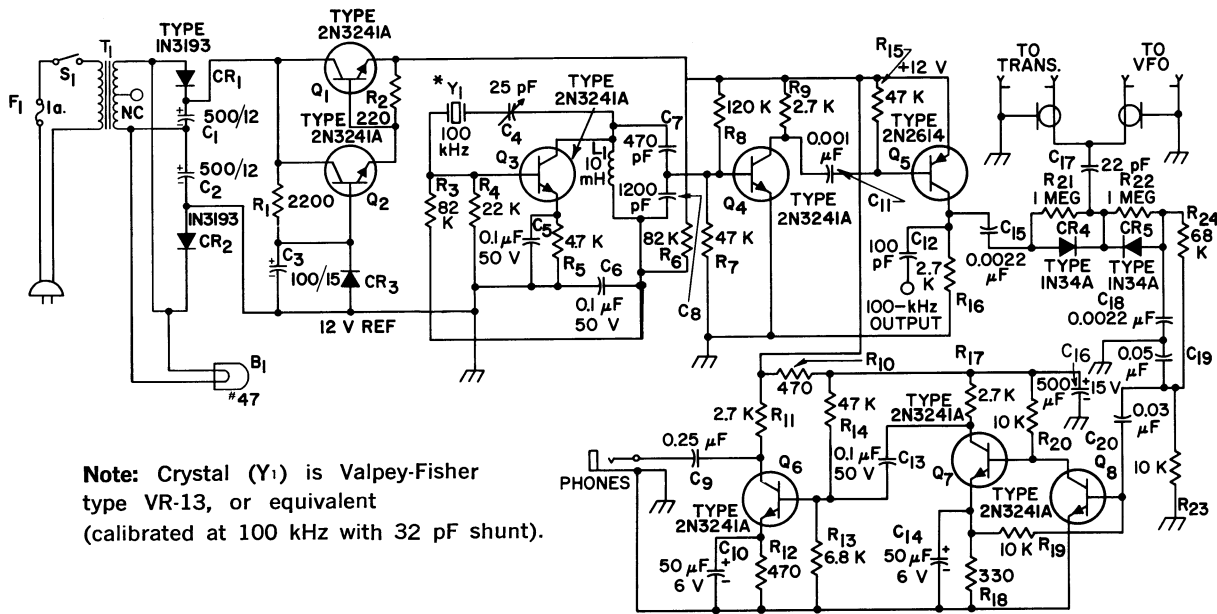

Note: Crystal (Y₁) is Valpey-Fisher type VR-13, or equivalent (calibrated at 100 kHz with 32 pF shunt).

- B₁ — Lamp, No. 47
- C₁, C₂ — 500 μF, 12 volts
- C₃ — 100 μF, 15 volts
- C₄ — 25 pF, adjustable padder type, air dielectric (Hammarlund APC-25 or equiv.)
- C₅, C₆, C₁₃ — 0.1 μF, 50 volts, ceramic
- C₇ — 470 pF, 500 volts, silver mica type
- C₈ — 1,200 pF, 500 volts, silver mica type
- C₉ — 0.25 μF, 200 volts, paper
- C₁₀, C₁₄ — 50 μF, 6 volts
- C₁₁ — 0.001 μF, 1,000 volts, ceramic
- C₁₂ — 100 pF, 1,000 volts, ceramic
- C₁₅, C₁₈ — 0.0022 μF, 1,000 volts, ceramic
- C₁₆ — 500 μF, 15 volts
- C₁₇ — 22 pF, 1,000 volts, ceramic
- C₁₉ — 0.05 μF, 50 volts, ceramic
- C₂₀ — 0.03 μF, 50 volts, ceramic

- CR₁, CR₂ — Diodes, RCA 1N3193
- CR₃ — Reference diode, 12 volts
- CR₄, CR₅ — Signal diodes, type 1N34A
- F₁ — Fuse, 1 ampere
- L₁ — RF choke, 10 mH (Miller 70F-102A1 or equiv.)
- Q₁, Q₂, Q₃, Q₄, Q₆, Q₇, Q₈ — Transistors, RCA-2N3241A
- Q₅ — Transistor, RCA-2N2614
- (Note: All following resistors ½ watt)
- R₁ — 2,200 ohms
- R₂ — 220 ohms
- R₃, R₆ — 82,000 ohms
- R₄ — 22,000 ohms
- R₅ — 4,700 ohms
- R₇, R₁₄, R₁₅ — 47,000 ohms
- R₈ — 120,000 ohms
- R₉, R₁₁, R₁₆, R₁₇ — 2,700 ohms
- R₁₀, R₁₂ — 470 ohms
- R₁₃ — 6,800 ohms

- R₁₈ — 330 ohms
- R₁₉, R₂₀, R₂₃ — 10,000 ohms
- R₂₁, R₂₂ — 1 megohm
- R₂₄ — 68,000 ohms
- S₁ — Switch, SPST toggle, 3A, 125 volts
- T₁ — Transformer, 6.3 volts, 1.2 amperes (Thordarson 21F09 or equiv.)
- Y₁ — Crystal, Valpey-Fisher type VR-13 or equivalent (calibrated at 100 kHz with 32 pF shunt)

Miscellaneous — 1 crystal socket for HE6/U; 1 headphone jack; 1 aluminum two-piece Minibox (or equiv.), 5-by-4-by-3 inches; 1 phenolic circuit board, 3-by-4½ inches; 2 UHF coaxial connectors (Amphenol SO239 or equiv.); 1 binding post (E. F. Johnson six-way type or equiv.)

Figure 1: Schematic diagram and Parts List of W2YM's VFO calibrator.

capacitor, C_4 (xtal adjust), is connected in series with the crystal so that oscillation can be adjusted to exactly 100 kHz. Capacitors C_7 and C_8 are used as a voltage divider to reduce the coupling to the input of the two-stage wave-shaping amplifier, Q_4 and Q_5 , and thus prevent loading of the secondary-standard oscillator. The two-stage wave-shaping amplifier provides the following advantages:

1. It prevents any reflection of the output load from affecting the frequency of the 100-kHz secondary-standard oscillator.

2. It shapes the output wave so that the harmonics are of greater strength.

The output of the two-stage wave-shaping amplifier is connected to one input of a two-diode product detector, CR_4 and CR_5 , and the VFO to be calibrated is connected to the other input. The wave-shaping amplifier output is also connected to a binding-post terminal so that the unit can be used as a conventional 100-kHz crystal calibrator. The values of the components shown in the circuit diagram have been chosen for a peak VFO signal level of 2 to 3 volts. For larger VFO signals, it will be necessary to replace the 22-pF capacitor, C_{17} , with some type of capacitive or resistive attenuator.

A three-stage amplifier — Q_6 , Q_7 , Q_8 — is used to amplify the extremely low audio output of the two-diode product detector to a comfortable head-phone level. The power supply for the complete unit is regulated by use of a zener reference diode, CR_3 , and a two-transistor regulator, Q_1 and Q_2 .

Construction

The complete calibrator unit is built into a 5-by-4-by-3-inch aluminum two-piece Minibox. The 100-kHz crystal oscillator, the two-stage wave-shaping amplifier, the diode product detector, and the three-stage audio amplifier are all assembled on a 3-by-4½-inch phenolic circuit board. This method of construction, illustrated in Figures 3 and 4, results in a convenient, rugged, and compact design. A full-size layout of this board is provided in Figure 2. It may be cut out and taped to the board for use as a drilling template. Terminal connectors for the circuit board are made from small pieces of No. 14 bus wire about one inch in length. This bus wire is bent into a "J" shape; pushed through the No. 54 holes; and then bent around to lock the terminal in place.

The crystal socket and the air capacitor used for setting the frequency are mounted on a small piece of aluminum which is attached to one end of the circuit board. The circuit board is separated from the Minibox by threaded, ⅜-inch, 4-40 spacers and 4-40 screws. RF connections to the VFO and transmitter are accomplished through standard UHF coaxial connectors mounted on the rear of the unit. The 100-kHz output terminal is also mounted on the rear of the unit.

Adjustment and Operation

The adjustment of the 100-kHz secondary-standard oscillator to precisely 100 kHz is easily accomplished by comparison of its harmonic with that of the primary standard, WWV. For the best beat signal, the 100-kHz output of the calibrator should be loosely coupled to the antenna of the receiver tuned to WWV. Capacitor C_4 should then be adjusted through the crystal-adjustment hole until a zero beat exists between the secondary standard and WWV. It would be well to wait for the quiet period of WWV's transmission (when there is no 440-Hz modulation) to be absolutely certain that the secondary standard is beating with the carrier and not with the modulation.

The use of the calibrator is extremely simple. It is inserted in the RF line of the VFO by connecting the VFO to the input coaxial connector and the transmitter to the output connector. When power is applied to the unit and headphones are inserted in the phone jack, a slight hissing noise should be heard. This noise indicates that the audio amplifier is active. At, or near, the even 100-kHz points on the VFO, low beat notes should be heard. Calibration of the dial can then be performed by zero-beating the VFO at those points. Lower-volume beats may be heard at the 50-kHz points on the dial, and in most cases it is also possible to hear the 33-, 25-, and 20-kHz beats, especially if the fundamental operating frequency of the VFO is below 5 MHz.

With many of today's amateur-radio receivers designed solely for hamband reception, the VFO calibrator is especially applicable to oscillators operating at frequencies outside the hambands. In addition, the unit can prove very useful for calibrating certain types of test equipment and for allowing the VFO to be used as a hamband frequency meter.

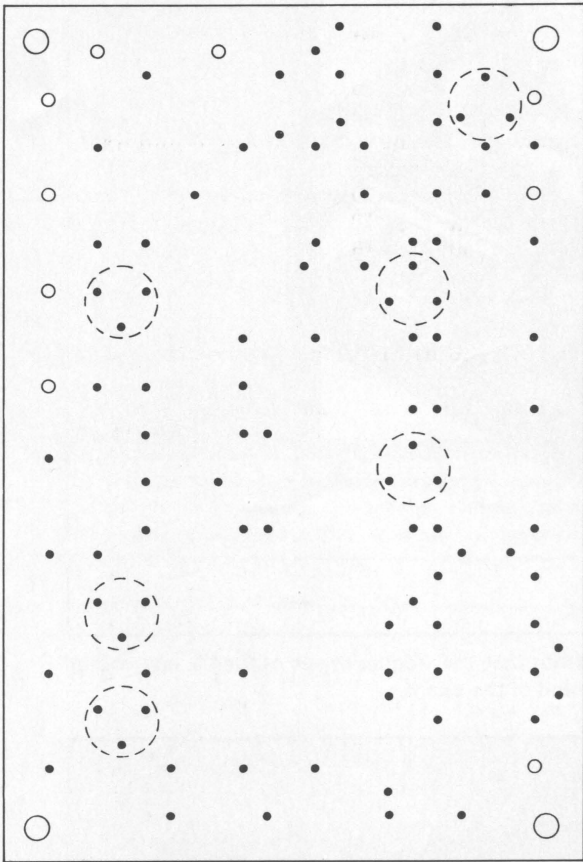

Figure 2: Bottom view of 3-by-4 1/2-inch circuit board is shown to full scale and can be cut out and taped to phenolic board for use as a drilling template. Note that holes are of three sizes and, from largest to smallest respectively, are made with No. 32, No. 54, and No. 60 drills.

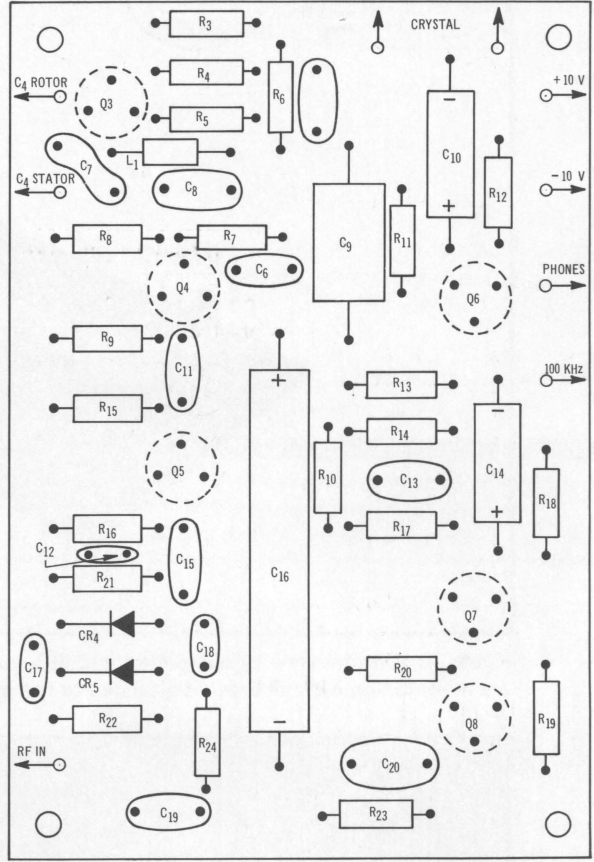

Figure 4: Top view of circuit board with parts layout.

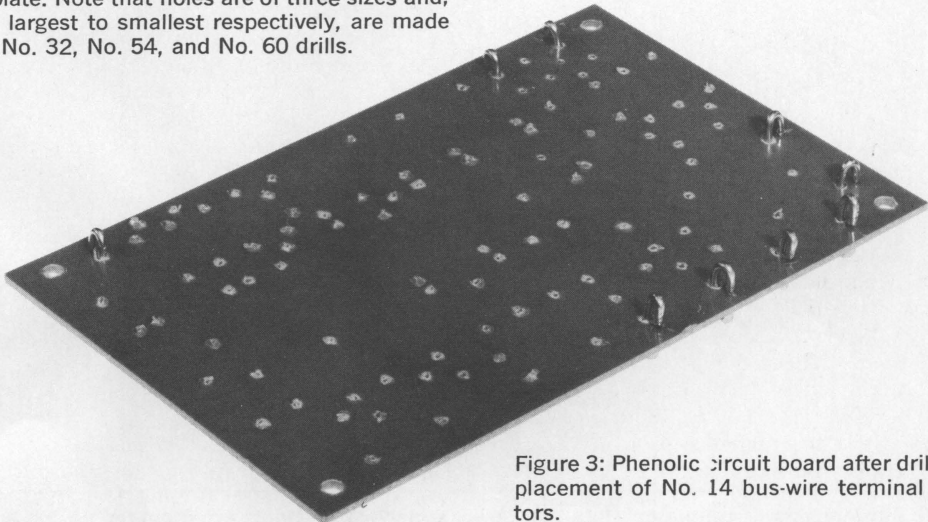

Figure 3: Phenolic circuit board after drilling and placement of No. 14 bus-wire terminal connectors.

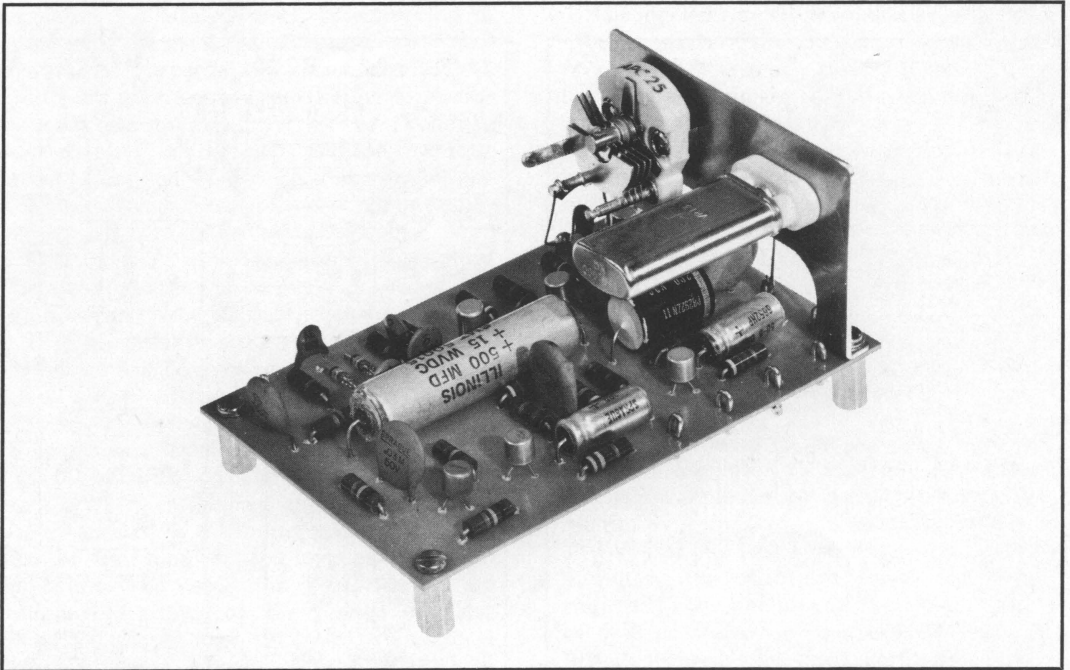

Figure 5: Pictorial view of completed circuit board. Note that the frequency-set capacitor and crystal are mounted on a small bracket attached to the right end of the board.

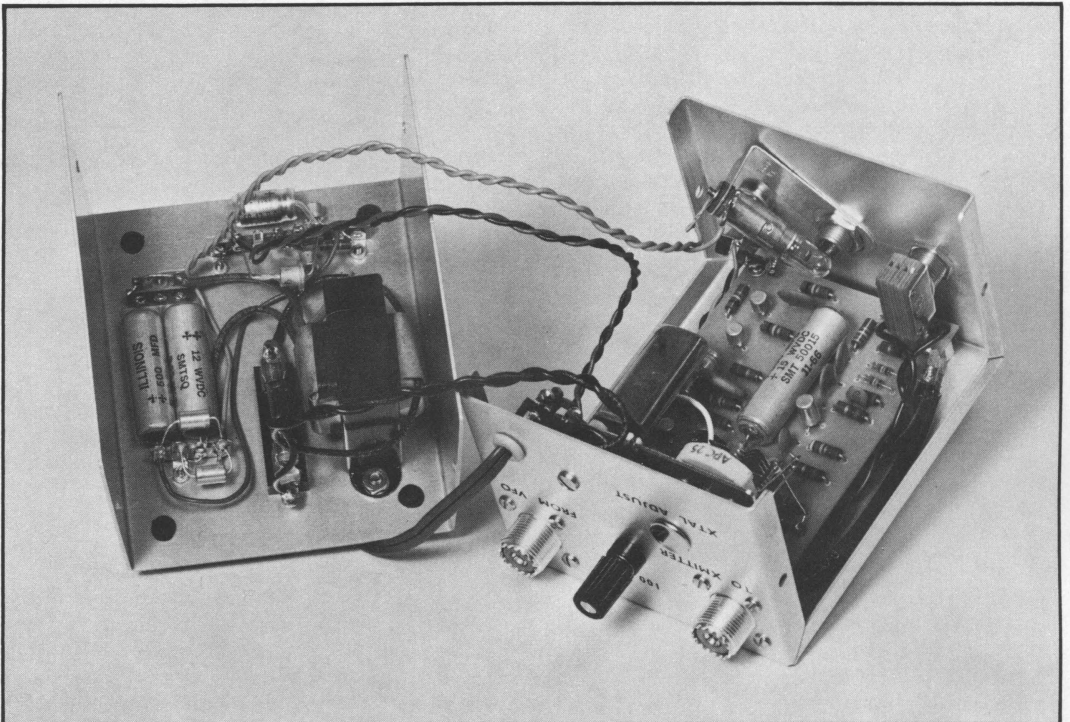

Figure 6: Internal view of calibrator. Note that power supply components are mounted on the bottom cover of the Minibox.

RCA HAM TIPS is published by RCA Electronic Components and Devices, Harrison, N. J. It is available free of charge from participating RCA Industrial Distributors. It is also available on a two-year subscription basis (\$1 for eight issues to cover costs of handling and mailing). Please make check or money order payable to Radio Corporation of America, and remit to "Radio Corporation of America, Section 882, Harrison, N. J. 07029."

DISTRIBUTED BY
 GEORGE D. BARBEY CO., INC.
 READING LEBANON
 LANCASTER POTTSTOWN

BLK RT
 ADL 7/8¢ PD.



Information furnished by the Radio Corporation of America is believed to be accurate and reliable. However, no responsibility is assumed by RCA for its use; nor for any in-

fringements of patents or other rights of third parties which may result from its use. No license is granted by implication or otherwise under any patent or patent rights of RCA.

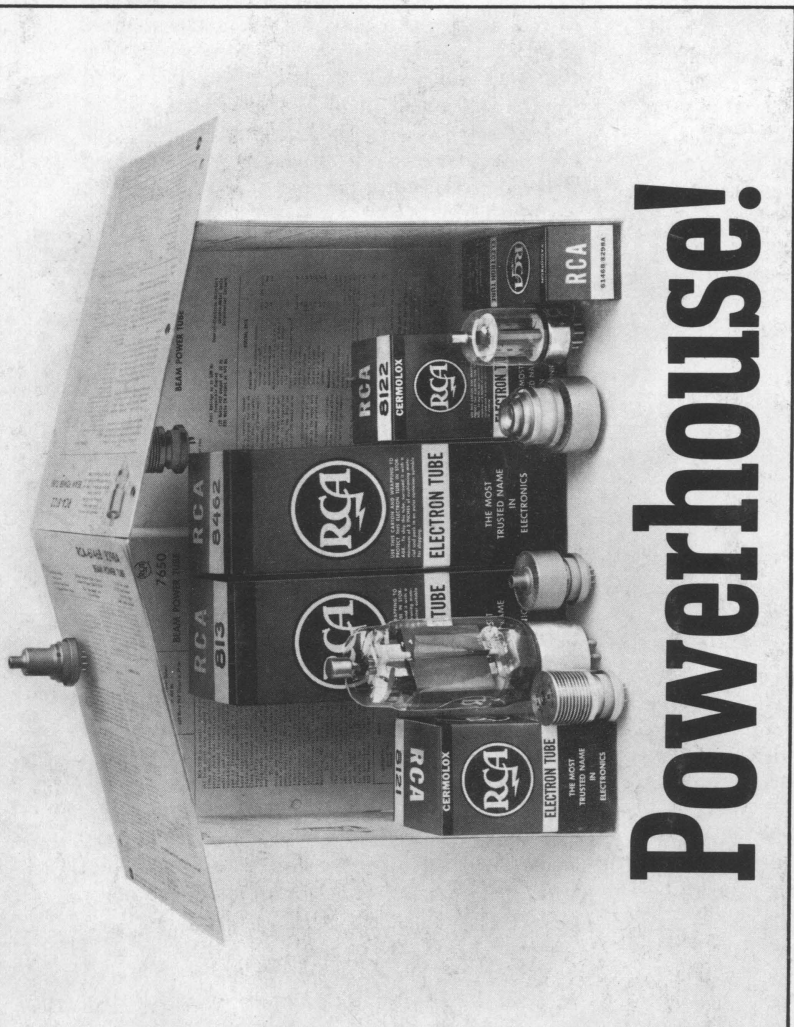

Powerhouse!

At RCA, power tube engineers are constantly working to improve the line—to provide the best possible tube for each amateur's choice of band, mode, and power. Check the tabulation... see your authorized RCA industrial tube distributor for the right tubes for your rig—CW or phone—in the bands you operate. For specific tube data sheets write to RCA Commercial Engineering, Harrison, N. J. 07029.

RCA Electronic Components and Devices
The Most Trusted Name in Electronics



A FEW OF THE MANY RCA POWER TUBES FOR AMATEUR USE			
Frequency	Power	Tube Type	Remarks
Up to 60 MHz	low	6146B/8298A	The latest version of the original RCA-developed "standard"
	medium high	pair of 6146B/8298A AF modulator 813	General use RF amplifier or AF modulator
Up to 500 MHz	low	8072	Ideal for VHF/UHF
	medium	8462	Quick-heat type for mobile use
500 MHz and above	high	8121	No chimney or expensive socket required
	high	8122	Low-drive requirement
	high	7650	KW (CW) input up to 1215 MHz

Available from Your RCA Industrial Tube Distributor.